

Rescue manual

Information for emergency services

July 2017



© 2017 BMW AG Munich, Germany. Copying, reprinting or reproduction, even in excerpt form, the written permission of BMW AG Munich. 07/2017

General

Foreword

One of the main priorities of the products developed and realised by BMW is optimum safety under all conditions. By taking an holistic view, the precisely-coordinated active and passive safety systems exceed the requirements set down by law.

They also take into account the technical requirements for emergency crews. This approach also includes providing specific information about how to work with the BMW restraint and safety systems as well as tips for using emergency equipment.

This booklet is intended as a user guide for trained emergency crews. Knowledge of the function and operating principle of the safety systems and vehicle characteristics is also needed.

For emergency crews, the foremost priority is to save the lives of persons who have been involved in accidents without exposing the victims or themselves to additional danger.

This rescue manual contain information on how rapid and safe access to accident victims can be made easier. We recommend using state-of-the-art emergency equipment as the materials and production engineering used in the automotive industry are subject to ongoing developments.

This rescue manual was been drawn up in cooperation with the BMW fire brigade in Munich. As a rule, this rescue manual is updated twice a year. **Additionally, model-specific emergency services data sheets with detailed information are available.** In addition, the country-specific rescue guidelines as well as the occupational health and safe guidelines must be observed. The latest version can be found at <https://oss.bmw.de/index.jsp>.

BMW fire brigade Munich



Essential information

Both the medical and technical side of the emergency operation must be coordinated and the two aspects must dovetail.

Medical aspects

All efforts should be made to avoid dragging people out. The casualties should initially be left in the vehicle if they and emergency services are at no immediate risk.

The first thing is to gain access (support opening) to the (locked in or trapped) people. As with all other measures, the patients should be treated with all due care.

Immediate life-saving measures and the initial examination (basic check) are usually carried out inside the damaged vehicle. The medical treatment administered in the vehicle should be restricted to absolutely essential care. Depending

on the injured person's condition, this may however be very extensive. The emergency doctor or rescue personnel must be provided with access to the injured person (support opening) so that immediate life-saving emergency measures can be carried out. Depending on the pattern of injuries, persons who have been involved in accidents should essentially be immobilised, i.e. provided with appropriate splinting before they are extracted from the vehicle (rescue opening). The rescue opening should be of an adequate size and reflect the overall situation.

The casualties should receive continuous medical care during the technical stage of the rescue. As much of the technical emergency work as possible should be prepared while medical treatment is being given.

Exceptions which require a crash rescue.

- Immediate risk from acute threat, e.g. fire or other accidents following the initial one
- Medical reasons

BMW Assist emergency call

BMW vehicles with an activated BMW Assist emergency call system and valid service contract can automatically or manually establish an emergency call. This is normally directed to a BMW call center, which handles the telephone call and if necessary notifies the responsible rescue coordination center. When the crash sensors register a significant accident, the system activates an emergency call. With advanced emergency calls, data including details about the accident severity is transmitted automatically to the BMW call center. BMW automatically analyses this data based on medical and accident research and generates a simple-to-understand evaluation for the rescue coordination center, who can therefore more easily determine the most appropriate rescue support. Based on the GPS data transmitted from the vehicle, the BMW call center determines an exact address which, together with information about access to the accident site, they can pass on to the emergency services. Further customer and vehicle details are also available to the BMW call center, which can be passed on to help the rescue authorities if required. This emergency call system works independently from the customer's mobile phone. If there is no BMW call center for the location, or no connection can be established on the reserved GSM network, the system may attempt to establish an emergency call via the emergency call number (112).

Response of the restraint and safety systems after an accident

If a vehicle is stationary, the restraint systems will not normally be triggered.

Exceptions

- If the solid propellant in the gas generator (airbag) heats to above 200 °C
- If the airbag modules are subject to immense mechanical loads (sawing, drilling, grinding, welding)
- If the electric cables short circuit to activate the ignition squibs
- If a stationary vehicle is struck by another vehicle (if the triggering criteria are satisfied, the restraint systems are triggered)

Use of radio transceivers

It is perfectly safe for walkie-talkies to be used close to restraint systems that have not been triggered.

Using emergency equipment

Propping up vehicles

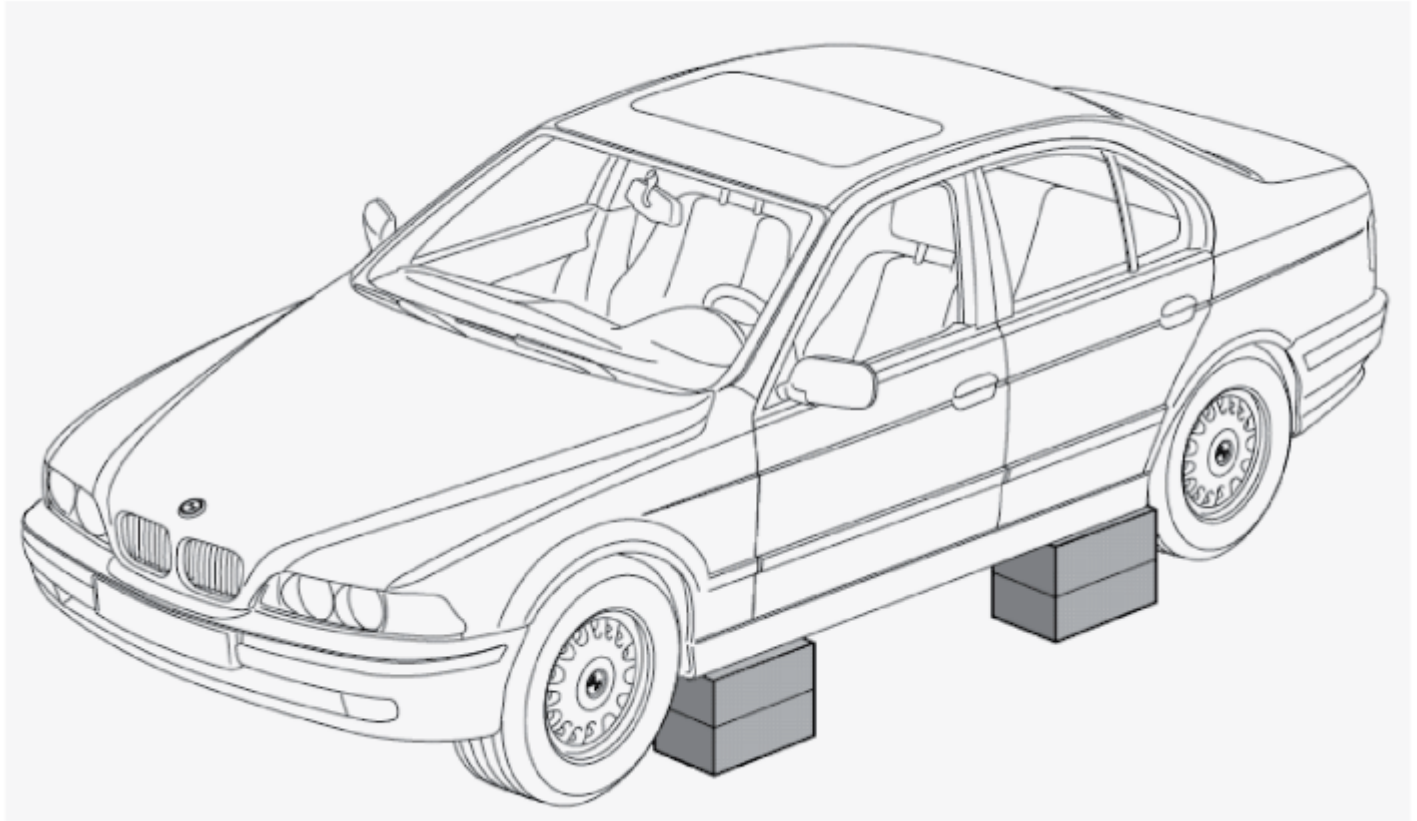

Example: Propping up vehicles

The vehicles can be propped up from underneath the whole of the side sill. The precise position and number of prop points must be determined as a function of the situation in hand.

Ideally, the mounting points for the jack should be used.

Opening doors

Version 1

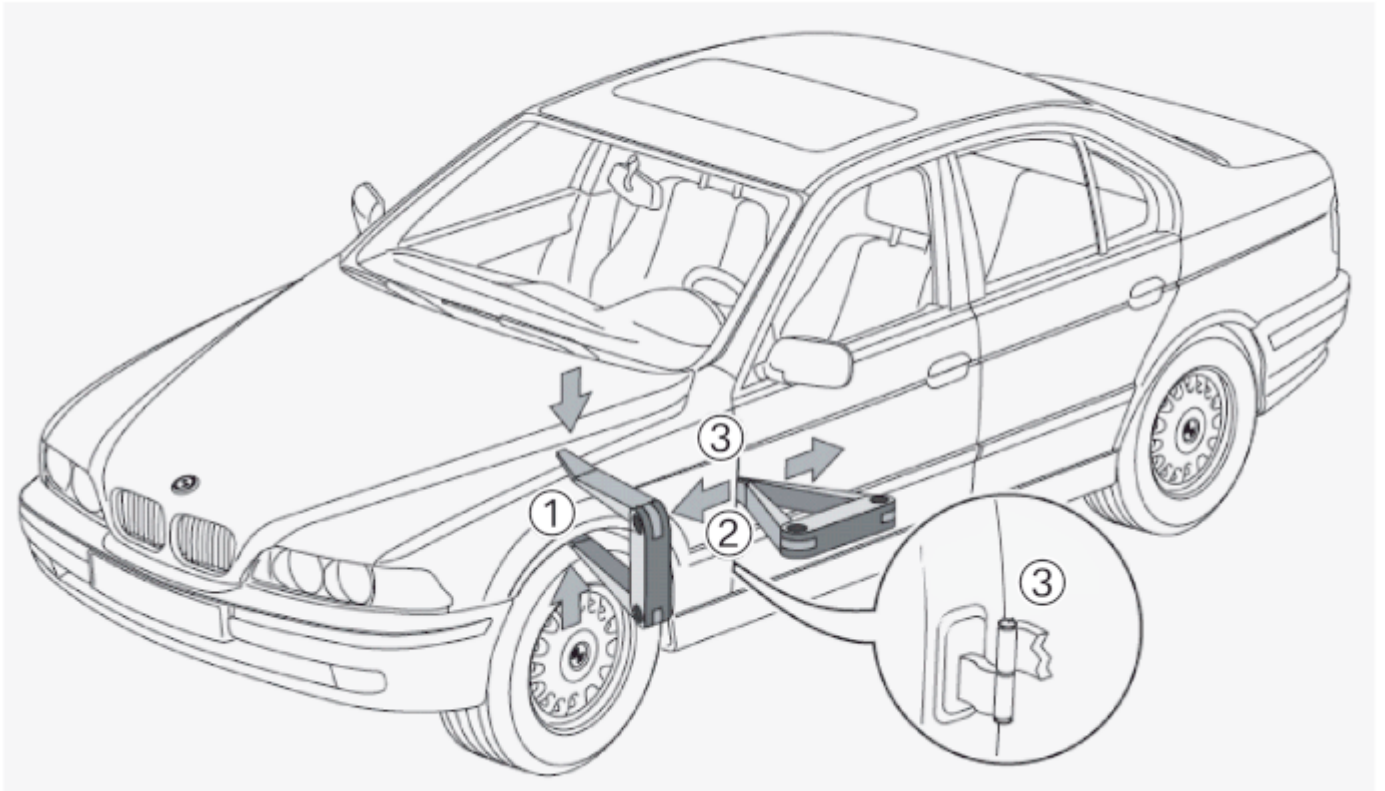

Starting points for opening the doors on the A-pillar

1 Press together the front side panel using the hydraulic rescue tool. This produces a larger gap between the front side panel and the front door.

2 Enlarge the gap at the same height as the hinges using the rescue tools. The precise position of the hinges for each vehicle has been highlighted on the emergency services data sheets.

3 Use the hydraulic cutter to cut off the hinges and open the door. Alternatively, the hinges and/or bolts can also be forced open using the emergency spreader.

Version 2

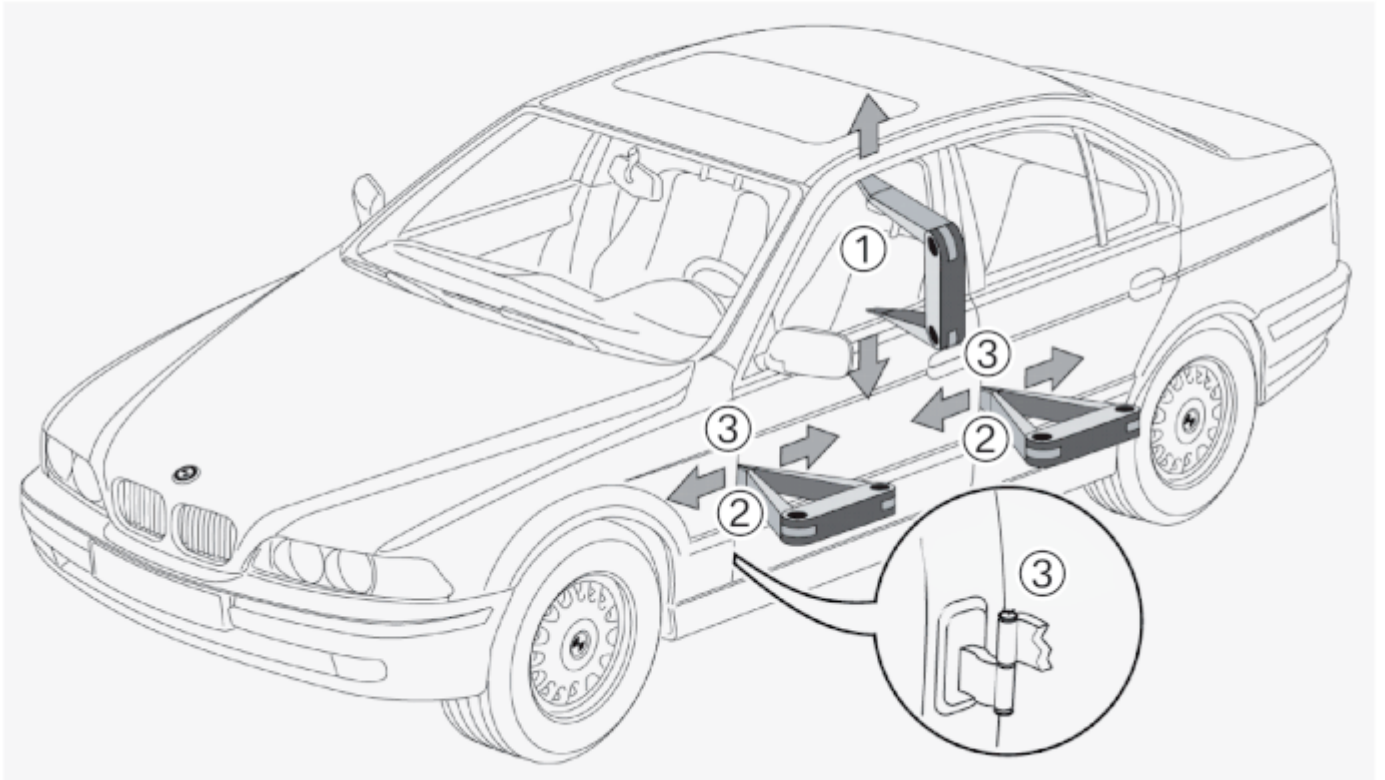

Starting points for opening the doors on the A-and/or B-pillar

1 Force apart the window frame using the hydraulic rescue tool. This produces a larger gap between the front door and B-pillar and/or between the front side panel and front door.

2 Enlarge the gap at the same height as the hinges using the rescue tools. The precise position of the hinges for each vehicle has been highlighted on the emergency services data sheets.

3 Open the door on the side of the hinges or lock (use the lock side for vehicles without horizontal side impact protection). The precise position of the hinges, door locks and side impact protection for each vehicle has been highlighted on the emergency services data sheets.

Forcing dashboard forwards

There are various ways of pushing the dashboard forwards.

The method to be used depends in part on the following:

- Mechanism of the accident
- Presence of an instrument panel support tube

Version 1

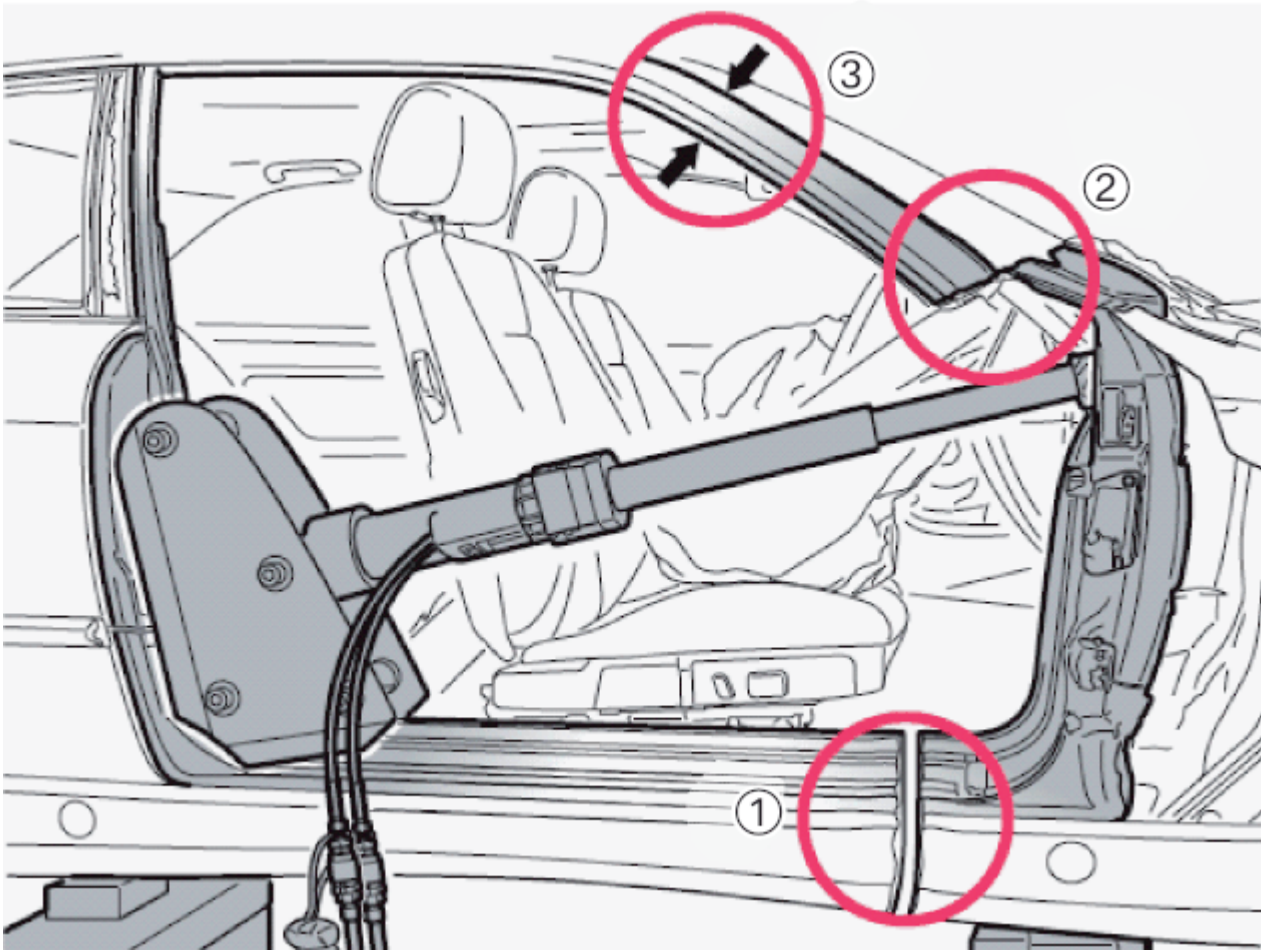

⚠ CAUTION

Moving rescue equipment.

Danger of injury!

- Make sure rescue equipment is correctly positioned.

- 1 Secure the vehicle floor against caving in by propping it up from below.
- 2 Carry out glass management (including cutting through the windscreen horizontally in area 2 or 3).
- 3 Use hydraulic shears to cut off the door at its hinges.
- 4 Use hydraulic shears to cut through the side sill 1 in front of the occupant towards the floor.
- 5 Use hydraulic shears to cut through both A-pillars in the bottom section 2 or in the top section 3.
- 6 Attach support angle to the B-pillar as shown. **Note:** If the emergency cylinder is too short, insert the support angle horizontally.
- 7 Where possible, position the emergency cylinder between the central bearing and the instrument panel.
- 8 Press away the front end.

Version 2

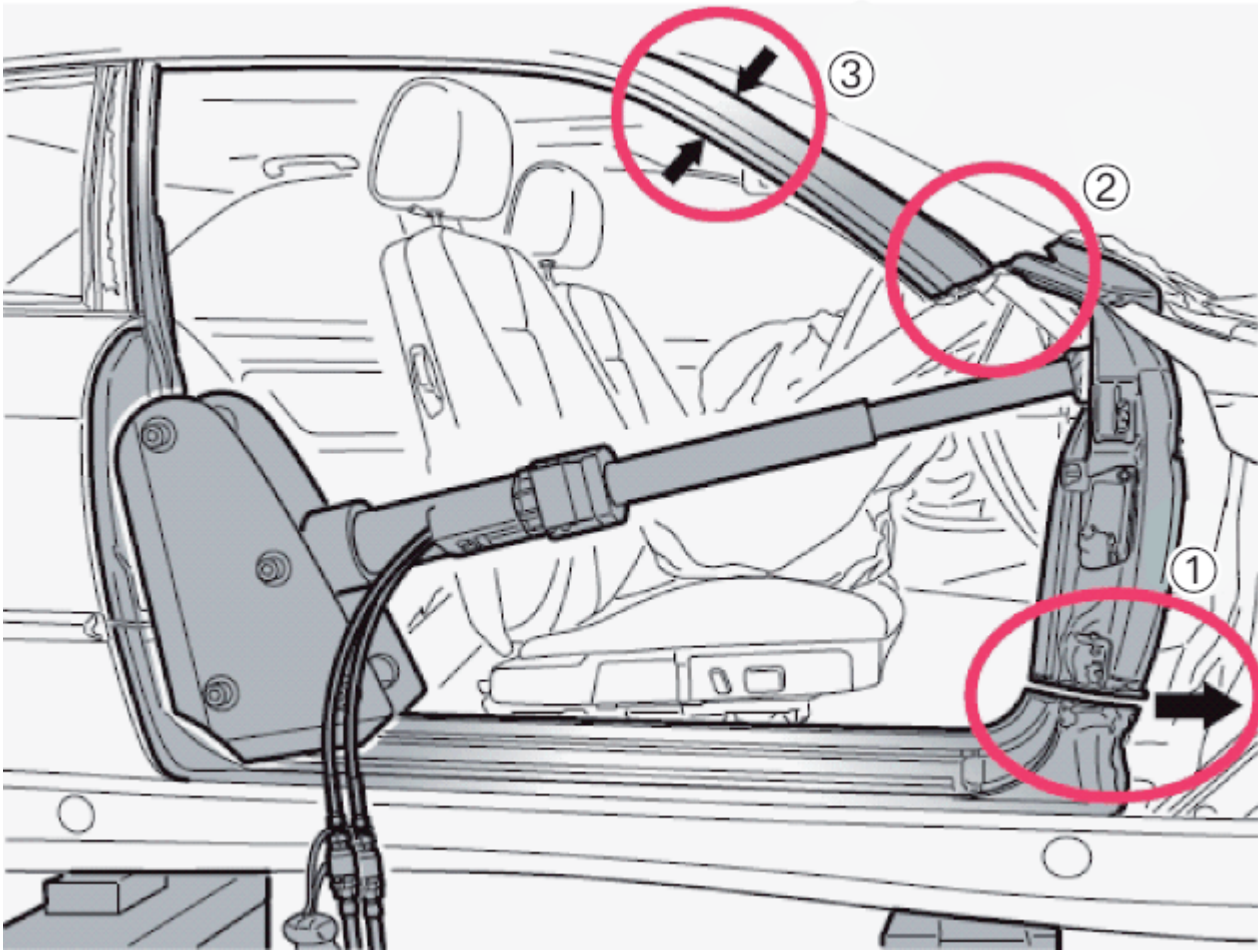

⚠ CAUTION

Moving rescue equipment.

Danger of injury!

- Make sure rescue equipment is correctly positioned.

- 1 Secure the vehicle floor against caving in by propping it up from below.
- 2 Carry out glass management (including cutting through the windscreen horizontally in area 2 or 3).
- 3 Remove the doors on both sides of the vehicle.
- 4 Use hydraulic cutters to cut through both side sills 1 in front of the occupant towards the front end. To achieve the desired effect, it may be necessary to continue the cut into the front wheel arch ("nibbling technique").
- 5 Use hydraulic shears to cut through both A-pillars in the bottom section 2 or in the top section 3.
- 6 Attach support angle to the B-pillar as shown. **Note:** If the emergency cylinder is too short, insert the support angle horizontally.
- 7 Where possible, position the emergency cylinder between the central bearing and the instrument panel.
- 8 Press away the front end.

Electric seat adjustment

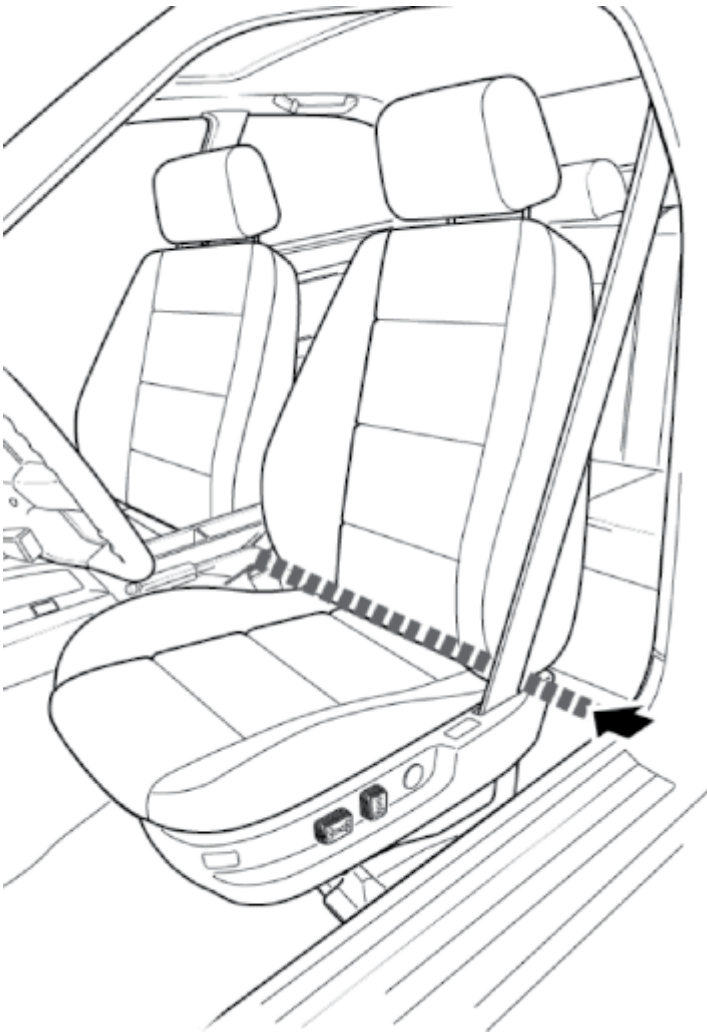

Since the seats in vehicles with electric seat adjustment cannot be adjusted once the battery has been disconnected, under certain circumstances we would recommend disconnecting in the area marked.

Securing vehicles

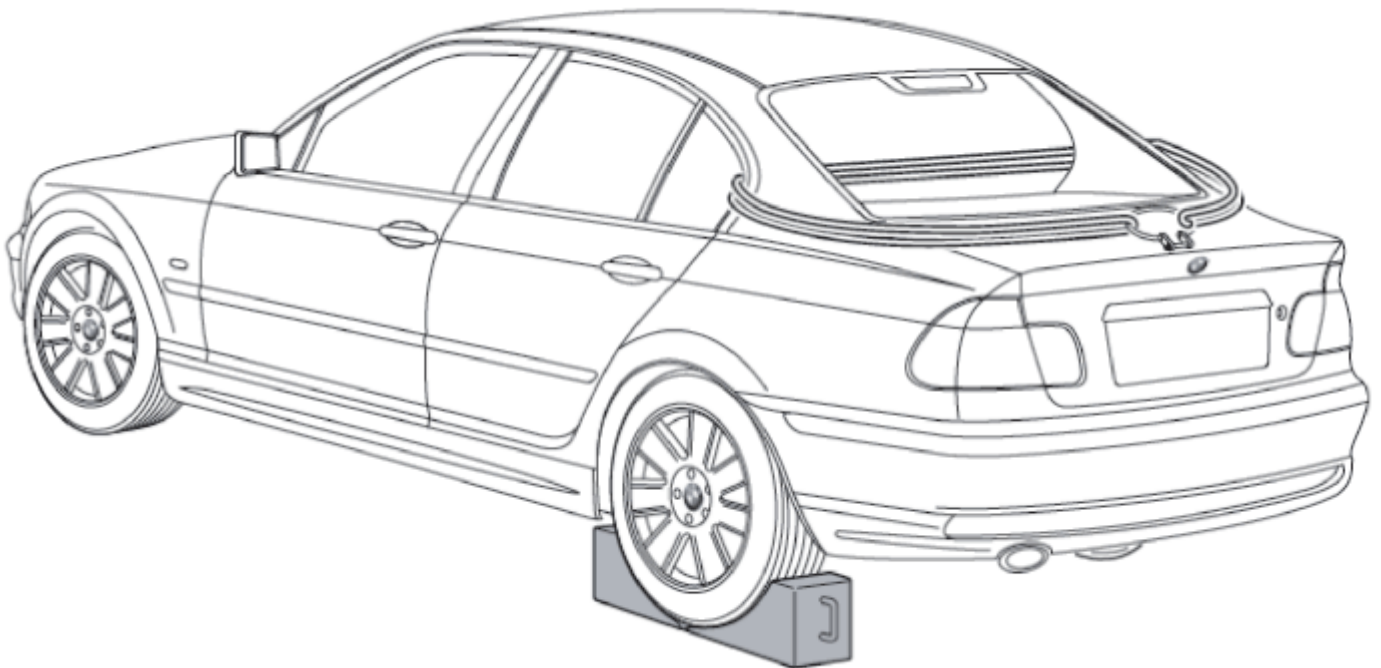

i TECHNICAL INFORMATION

The towing eye must not be used to recover or secure the vehicle.

Chock

Place chock in front of and behind the rear axle wheel on the side opposite that on which the vehicle will be raised. Ideally, the mounting points for the jack should be used.

Continuous loop

Secure the continuous loop to the rear or front by passing through the window openings and affix to a suitable counter support.

Front and rear axle

Place chock in front of and behind the rear axle wheel on the side opposite that on which the vehicle will be raised. Ideally, the mounting points for the jack should be used.

Safety concepts and systems

Complete overview of restraint and safety systems

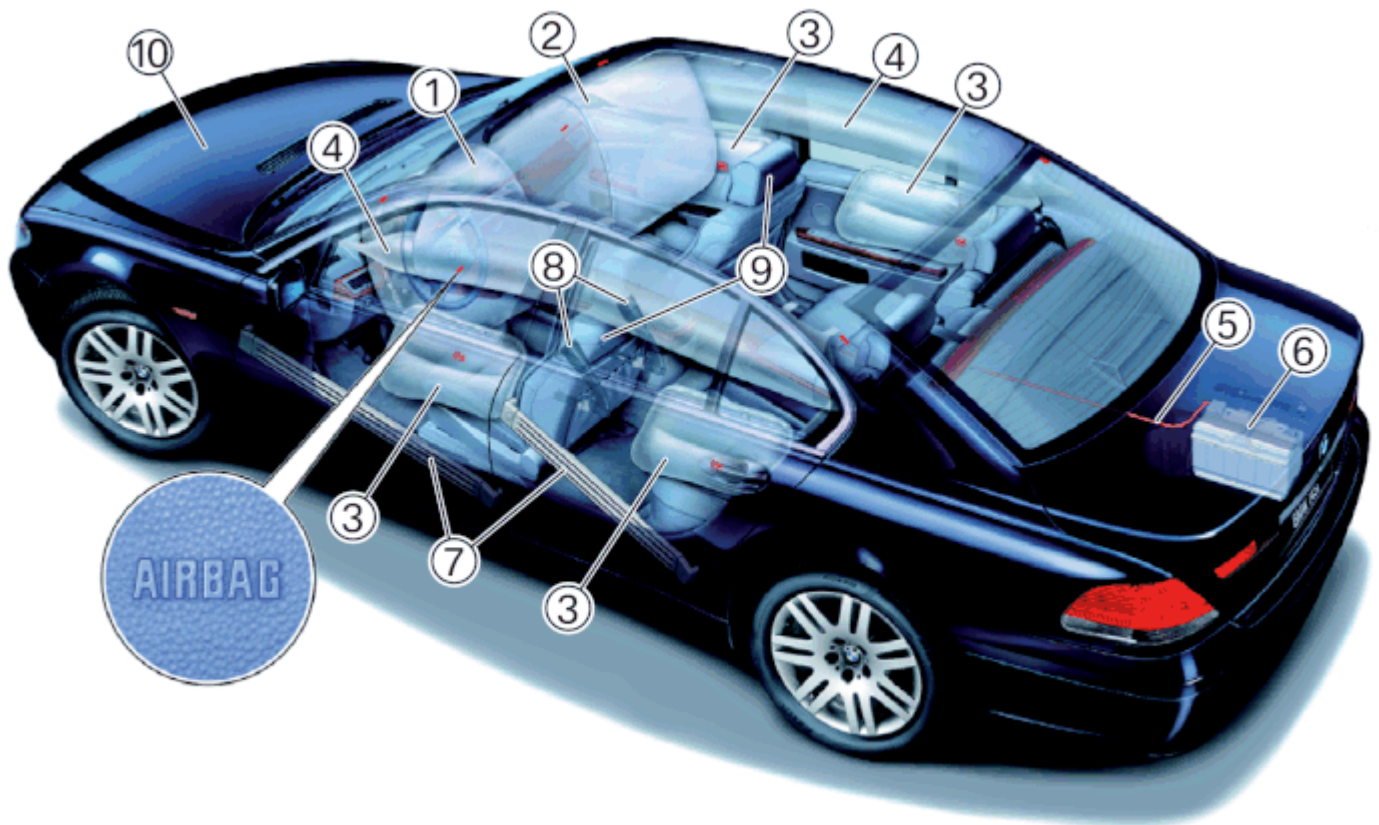

Index	Explanation
1	Driver's airbag
2	Front passenger airbag
3	Side airbag
4	Head airbag
5	Positive battery cable
6	Battery
7	Side impact protection
8	Seat belt tensioner
9	Active head restraint
10	Active bonnet

Identification of safety systems

Airbag system

Driver's airbag

SRS, SRS airbag or AIRBAG labelling on the steering wheel (steering wheel baffle plate)

Front passenger airbag

SRS, SRS airbag or AIRBAG labelling on the dashboard (passenger's side)

Side airbag

- Side airbag in the interior door frame (virtually all BMW models): SRS, SRS airbag or AIRBAG labelling on the door trim panel (front and rear) in the area of the door lock
- Side airbag in the front seat (all MINI models and a few BMW models): Side airbag in the front seat (all MINI models and a few BMW models):

Head airbag

Head airbag

Knee airbag

AIRBAG labelling on the glove box lid (top right) and/or on the steering column shroud (top left)

Seat belt tensioner

No identification

The vehicles contain four kinds of systems for reducing belt slack:

- Mechanical belt tensioners
- Pyrotechnic belt tensioners
- Pyrotechnic retractor tensioners / end fitting pretensioners
- Seat-integrated belt system (SGS)

Active head restraints

No identification.

The active head restraints are integrated into the driver's and front passenger seats.

Active head restraints that have not been triggered require no special attention.

Roll-over protection system

- 3-Series (E36): no identification
- 3-Series (E46): "Rollover protection system" identification on the top side of the head restraint on the rear seat
- 1-Series(E88), 3-Series(E93), 6-Series(E64): "Rollover protection system" identification. The rollover protection system is installed in 1 Series (E88), 3 Series (E36, E46, E93) and 6 Series (E64) convertibles only. Rollover protection bars that have not been activated require no special attention.

Active engine compartment lid

No identification.

Installation depending on series and national-market version.

Engine compartment lids that have not been activated require no special attention.

Child restraint system

Front passenger and side airbags can be switched off when using child restraint systems. Labels can be found near the airbag in question if this applies.

Airbag systems

Technical information

Use

In view of different legal requirements in Europe and the USA, different airbag variants are used in BMW vehicles.

Front airbag for driver I

Large air cushion fitted as part of the vehicle's standard equipment (the volumes used in the USA and European versions differ due to differing legislation)

Front airbag for driver II

Small air cushion (compact airbag; Eurobag) used in vehicles equipped with a sports steering wheel

Front airbag for front passenger

Air cushion, under the dashboard on the passenger's side

Side airbag

Side airbag, small air cushion on the inner door frame (front door and rear door) or in the outer sides of the front seats

ITS head airbag

Air pipes, from the bottom end of the A-pillar along the inside of the roof structure to just shortly before the C-pillar

Advanced inflatable tubular structure head airbag

Head airbag stretching from the A-pillar to the C-pillar; extension of the ITS head airbag with a canvas between the ITS airbag and roof frame

Head airbag

Head airbag stretching from the A-pillar to the C-pillar; extended covered area for the front and rear side window glass

Head airbag, rear

Small air cushion in the roof frame above the C-pillar

Knee airbag

Small air cushion, behind the glove box lid and/or behind the steering column shroud (only available in the US version)

Driver's airbag



Triggered driver's airbag

The driver's airbag is located in the steering wheel's impact absorber.

Acceleration is recorded and evaluated by a sensor. If the triggering threshold is exceeded, the airbag control unit and/or the satellite responsible (= intelligent sensor) transmits an ignition voltage to the ignition squib which then triggers the airbag.

The gas created by ignition escapes into the airbag which then unfolds in full.

Front passenger airbag

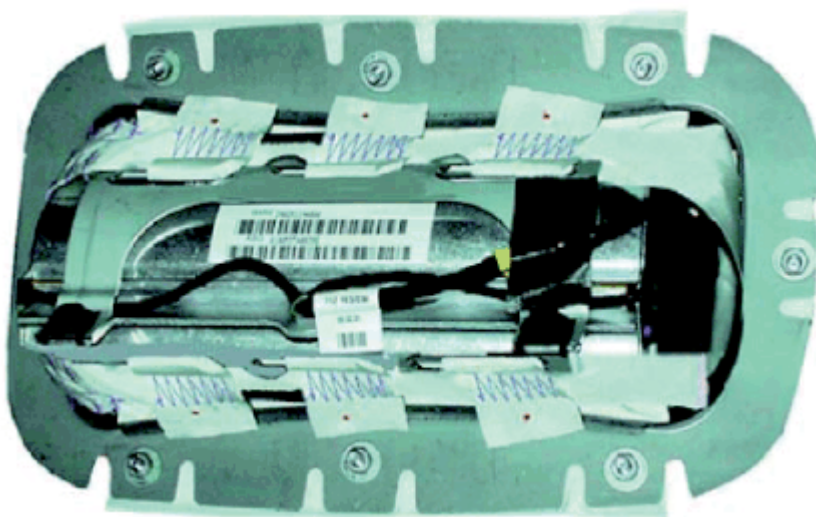

Front passenger airbag that has not been triggered

The front passenger airbag is located in the dashboard above the glove box on the passenger's side.

A seat occupancy detection feature has been integrated in the vehicle for many years to prevent the front passenger airbag from being unnecessarily triggered in the event of a crash when the front passenger seat is not occupied.

Using sensors in the front passenger seat and by evaluation of data in the airbag control unit and/or in the satellite (= intelligent sensor), above a weight of 12 kg the front passenger seat is recognised as being occupied and the system is activated.

Side airbag

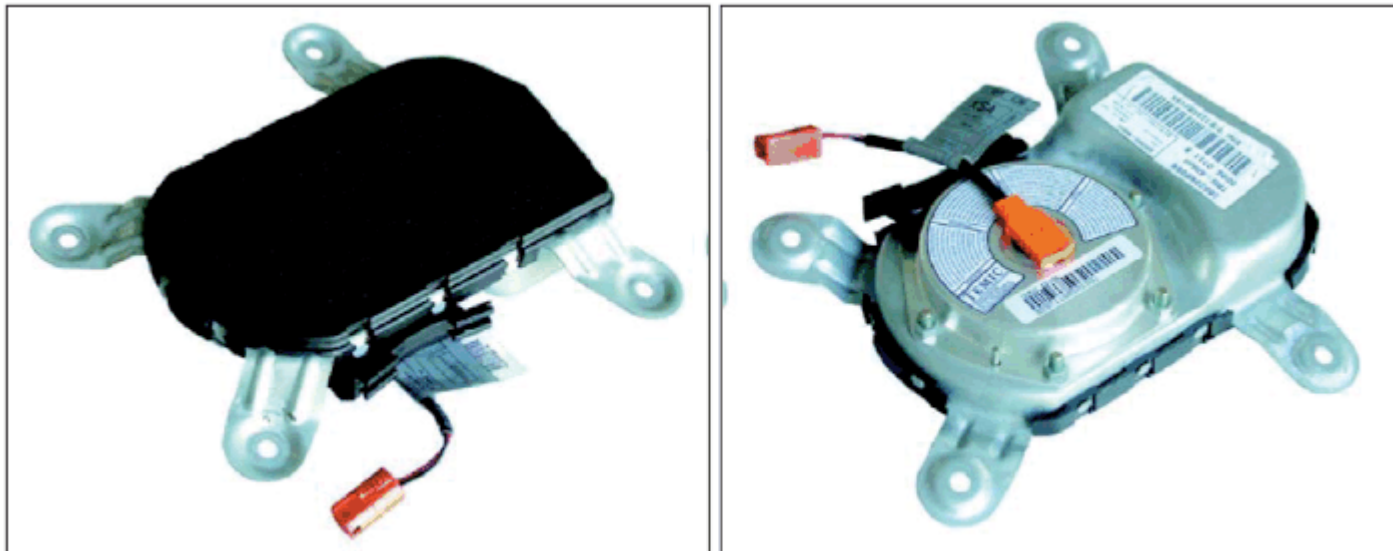

Side airbag not triggered

The side airbags are located behind the side trim panel in the door in most BMW models. On some BMW models, as well as on all MINI models, the side airbags are located to the side, in the backrest of the driver's and front passenger seats.

In the event of a side collision, the resulting lateral acceleration is recorded by sensors.

If the triggering threshold is exceeded, the airbag control unit and/or the satellite responsible (= intelligent sensors) activates the side airbags and, if fitted, also the head airbag.

ITS head airbag



Inflatable tubular structure not activated (in the roof area) and activated

The ITS head airbag, unlike other airbags, involves a tube system that is secured to the body with seat belt straps.

When the generator is ignited, the diameter of the head airbag increases and its overall length is reduced. This process stretches the head airbag between the lower end of the A-pillar and the rear mounting on the roof frame.

Unlike the front and side airbags that collapse relatively quickly after inflation, the head airbag retains its gas volume and therefore offers protection in the event of the vehicle rolling or secondary accidents.

The head airbag can be cut off or cut through at the seat belt straps.

AITS head airbag

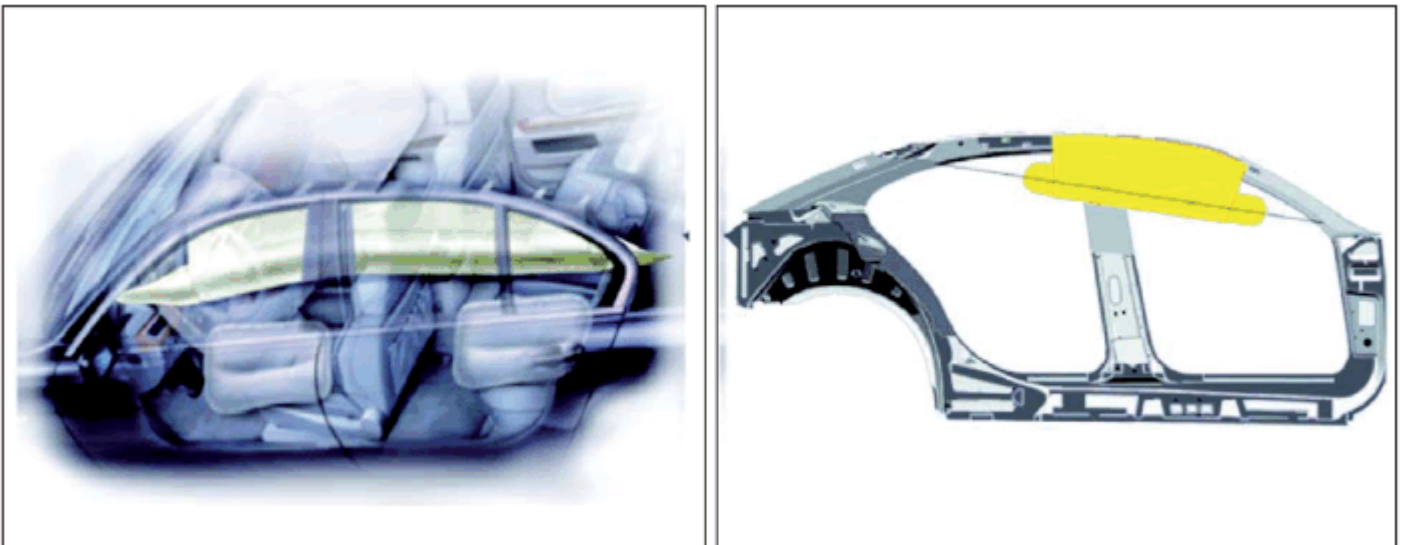

AITS for front and rear seat passengers (triggered)

The AITS head airbag is a head protection system like the ITS. Its advantage, however, lies in its curtain-like area protection.

The AITS prevents the head and limbs from swinging back and forth. This means that the neck experiences lower shearing forces and there are fewer head injuries. The AITS prevents the head and limbs from swinging back and forth. This means that the neck experiences lower shearing forces and there are fewer head injuries.

System features:

- Extended covered area for the front and rear side windows
- Protection from broken glass and penetrating objects
- Optimised covered area, even for very large occupants

Head airbag

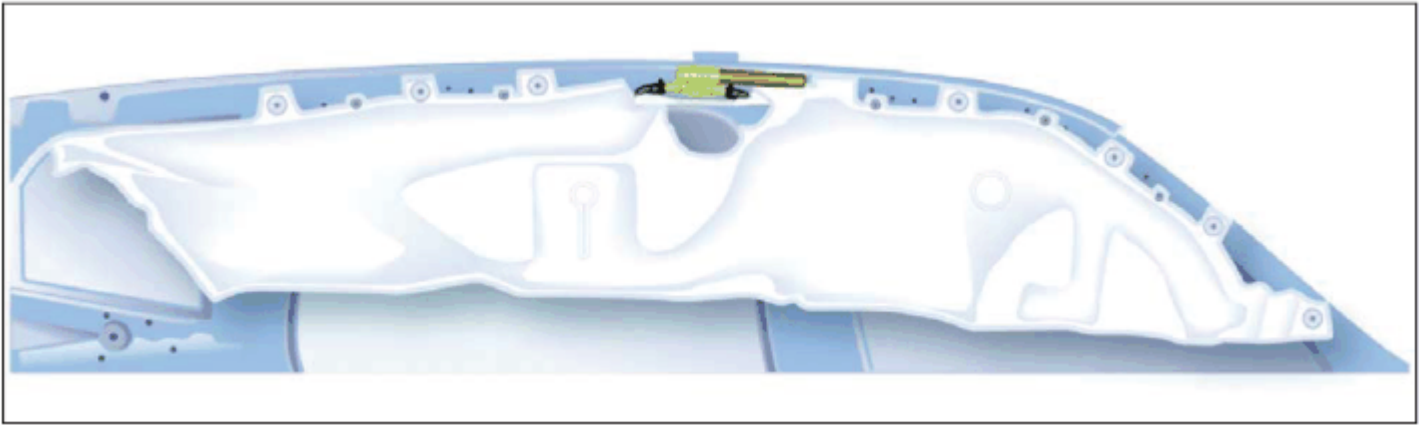

Head airbag activated

The head airbag stretches from the A-pillar to the C-pillar and covers the entire side area. It unfolds between the occupants, side window glass and pillar trim panels.

System features:

- Extended covered area for the front and rear side windows
- Protection from broken glass and penetrating objects
- Optimised covered area, even for very large occupants

The gas generator is activated in the event of a side collision. The resulting gas flows through the two gas lances into the airbag. The simultaneous filling of the airbag at the front and rear ensures a more even filling.

The mounting of the head airbag at the A-pillar and C-pillar ensures that the head airbag is brought into position. As it unfolds, the head airbag stretches between the side window glass, pillar trim panels and the occupants.

The closed system preserves the structural solidity and stability for several seconds.

Knee airbag

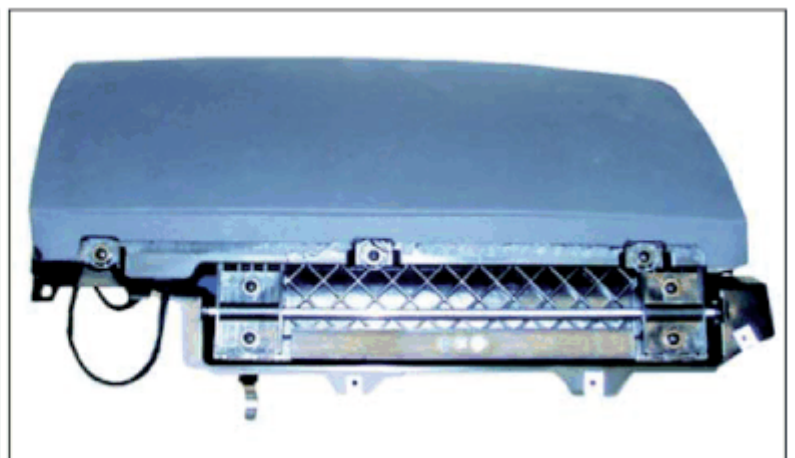
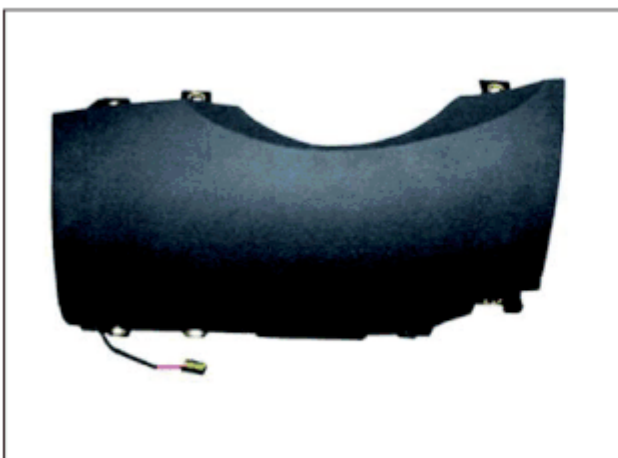

Knee airbag on driver's and passenger's sides.

In the event of a crash, when the driver or front passenger is not wearing a seat belt, the knee airbag will support their knees.

This results in the upper body being shifted forwards in a controlled manner and being caught by the airbag.

The knee airbag on the driver's side is located underneath the steering column behind a lid.

The knee airbag on the passenger's side is located in the lid of the glove box behind a cover.

Ignition sequence

The airbag is deployed by the airbag control unit and/or the responsible satellite (= intelligent sensor).

The integrated sensors activate the required systems when the triggering thresholds are exceeded. In the gas generator, the solid propellant sodium azide or nitro-cellulose mainly burn to nitrogen gas. Negligible volumes of carbon monoxide and nitrogen oxide are produced. This gas then flows into the airbag and unfolds it. As the airbag unfolds, the cover (impact absorber of driver's airbag, cover of the front passenger airbag, trim panel of the side/head airbags) tears off at the predetermined breaking points.

The deposits of talc from the airbag in the vehicle interior are totally safe.

Safety mechanisms

The restraint and safety systems are triggered by electronic and mechanical acceleration sensors. Two sensors that function independently of one another are always needed for airbag deployment.

Electronic acceleration sensors

Driver's and front passenger airbag, head and side airbags, belt tensioner and safety battery terminal.

Mechanical acceleration sensors (safing sensor)

The driver's and front passenger airbags are triggered in conjunction with the mechanical acceleration sensors.

Electronic side impact sensors

The side and head airbags are triggered in conjunction with the electronic acceleration sensors.

Airbag control unit

The airbag control unit is the central unit in the entire restraint and safety system and carries out the following tasks:

- Impact detection
- Calculation of triggering time for airbags, belt tensioner, safety battery terminal
- Ignition of airbags, belt tensioner and safety battery terminal
- Self-test
- Fault display and fault memory with diagnostic capability
- Seat occupancy and weight recognition for the front passenger seat

Satellites

Satellites consist of a control unit with an integrated sensor system for activating actuators (airbags, belt tensioner, etc.). Satellites are able to make intelligent decisions on selective and fast triggering of actuators. Any functions not needed are not activated.

In the 7 Series (E65/66) models, the Intelligent Safety Integration System (ISIS) and, from the 5 Series (E60/E61), 6 Series (E63/E64) and Z4 (E85) models, the passive safety system (ASE) are installed with satellites.

Belt tensioner - technical information

Four different belt tensioner systems are used in the vehicles:

- Mechanical belt tensioners
- Pyrotechnic belt tensioners
- Pyrotechnic retractor tensioners / end fitting pretensioners
- Seat-integrated belt system (SGS)

All the systems have the same goal of reducing belt slack. This is the biomechanical load to which the human body is subjected after an accident.

Mechanical belt tensioner



On the mechanical belt tensioner, a mechanical sensor detects a crash and triggers the release of the tensioner energy via a switching mechanism. A force transfer element pulls the seat belt buckle obliquely downwards to tension the seat belt strap against the occupant's body. When the belt force is subsequently built up, a locking system blocks the seat belt buckle in any tensioned position. The occupant is therefore secured more effectively to the vehicle.

In the event of a head-on collision, the mechanical impact sensor activates the system. A preloaded spring pulls the seat belt buckle back. The shoulder and lap belts are tightened.

Pyrotechnic belt tensioner



The pyrotechnic belt tensioner is a further development of the mechanical belt tensioner for reducing belt slack even more quickly.

The pyrotechnic belt tensioners are activated by the airbag control unit and/or the seat satellites. A pyrotechnic unit is responsible for tightening the seat belt.

Pyrotechnic retractor tensioner / end fitting pretensioner

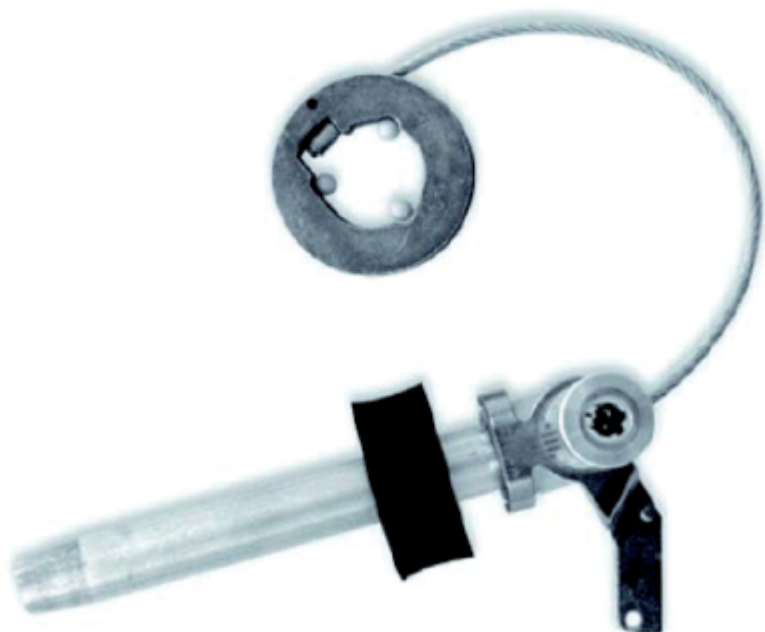

Pyrotechnic retractor tensioner

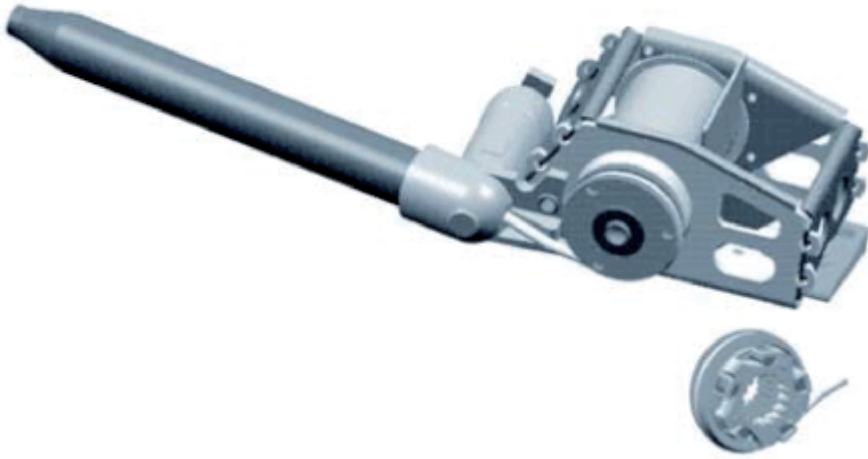

Pyrotechnic end fitting pretensioner

The pyrotechnic retractor tensioner reduces belt slack by creating friction in the seat belt guides, primarily in the shoulder region.

Sensors and control electronics activate a pyrotechnic unit which starts the automatic shaft rotating through a wound cable.

To eliminate the film spool effect, a clamping fixture holds the seat belt strap secure when the occupant moves forwards.

At present, pyrotechnic end fitting pretensioners can only be fitted on the outer seats in the rear passenger compartment.

Since there is little space under the rear seat, a solution similar to that of the front belt tensioner is not possible. Belt slack is therefore overcome by drawing in the seat belt strap at the end fitting. The automatic reel forms the top attachment point, the end fitting pretensioner the bottom one.

The end fitting pretensioners are activated by the seat satellites and/or the seat module. A pyrotechnic unit is responsible for tightening the seat belt.

Seat-integrated belt system



In the seat-integrated belt system (SGS) all the belt elements, including the reversing points, are moved into the seats. In the event of a crash, all forces in vehicles without B-pillars are absorbed by the floor assembly.

The head restraint and top belt reversing point also automatically adjust depending on the seat length adjustment.

A top belt tensioner fitted on the top belt feed also restricts the amount by which the occupant moves forwards in the event of a crash. The overall arrangement reduces the free seat belt strap lengths to a minimum.

Since all three belt points move with the seat adjustment, the belt geometry automatically guarantees the body is restrained by the belt as best as possible.

Active head restraint



The active head restraints are integrated into the driver's and front passenger seats.

Function

In the event of a rear-end collision, the head is jolted to the rear because it becomes the most inactive part of the body due to the long distance to the head restraint. This jolt movement may result in cervical injuries (whiplash).

To reduce the distance between the head and head restraint, the active head restraint swings forward to the head in the event of a rear-end collision.

Two additional impact sensors and/or satellites in the rear of the vehicle activate the gas generator in the backrest during a rear-end collision. The gas generator's piston rod moves a sliding piece. This sliding piece moves forward the support tube to which the head restraint is attached, and thereby reduces the distance between the head and head restraint.

Depending on the height adjustment of the head restraint, adjustment travel of 40 to 60 mm may be produced.

Roll-over protection system

The rollover protection system is an additional safety function in some BMW convertible models. In the event of rollover or other situations that encourage the vehicle to roll over, the rollover protection system extends, locks positively and thereby helps maintain a large enough survival space for occupants.

The first thing is to gain access (support opening) to the (locked in or trapped) people. As with all other measures, the patients should be treated with all due care.

Function of the BMW 1-Series E88, 3-Series E93, 6-Series E64 and MINI Convertible R57



Rollover protection of the 6-Series E64 in normal position and triggered (right)

Two extendable rollover protection bars are stored in a structure behind the two rear seats.

The rollover protection system is a separate system and is not linked to the airbag control unit.

On models in the 3 Series (E93), the control electronics (rollover protection controller) are installed in the structure next to the right-hand rollover protection bar.

On models in the 6-Series (E64), the rollover sensor is located in one of the satellites.

The rollover protection bars are retracted in the structure during normal operation. The rollover protection bars are pre-tensioned in the direction of extension by a spring and held by the lock on the actuator.

BMW 3 Series E93 and MINI Convertible R57

If the control electronics of the rollover protection controller detect an imminent rollover, the two actuators are triggered directly. The rollover protection bars are extended by spring force and mechanically locked in their end position.

BMW 6-Series E64

If the rollover sensor in the satellite detects an imminent rollover, the data is transmitted via a light-linked bus system to the safety and gateway module (SGM). At the same time, the signal to release the rollover protection system is sent via a copper cable (arming cable) to the SGM. This triggers the two actuators via an output stage. The rollover protection bars are extended by spring force.

Function of the 3-Series E36 and E46

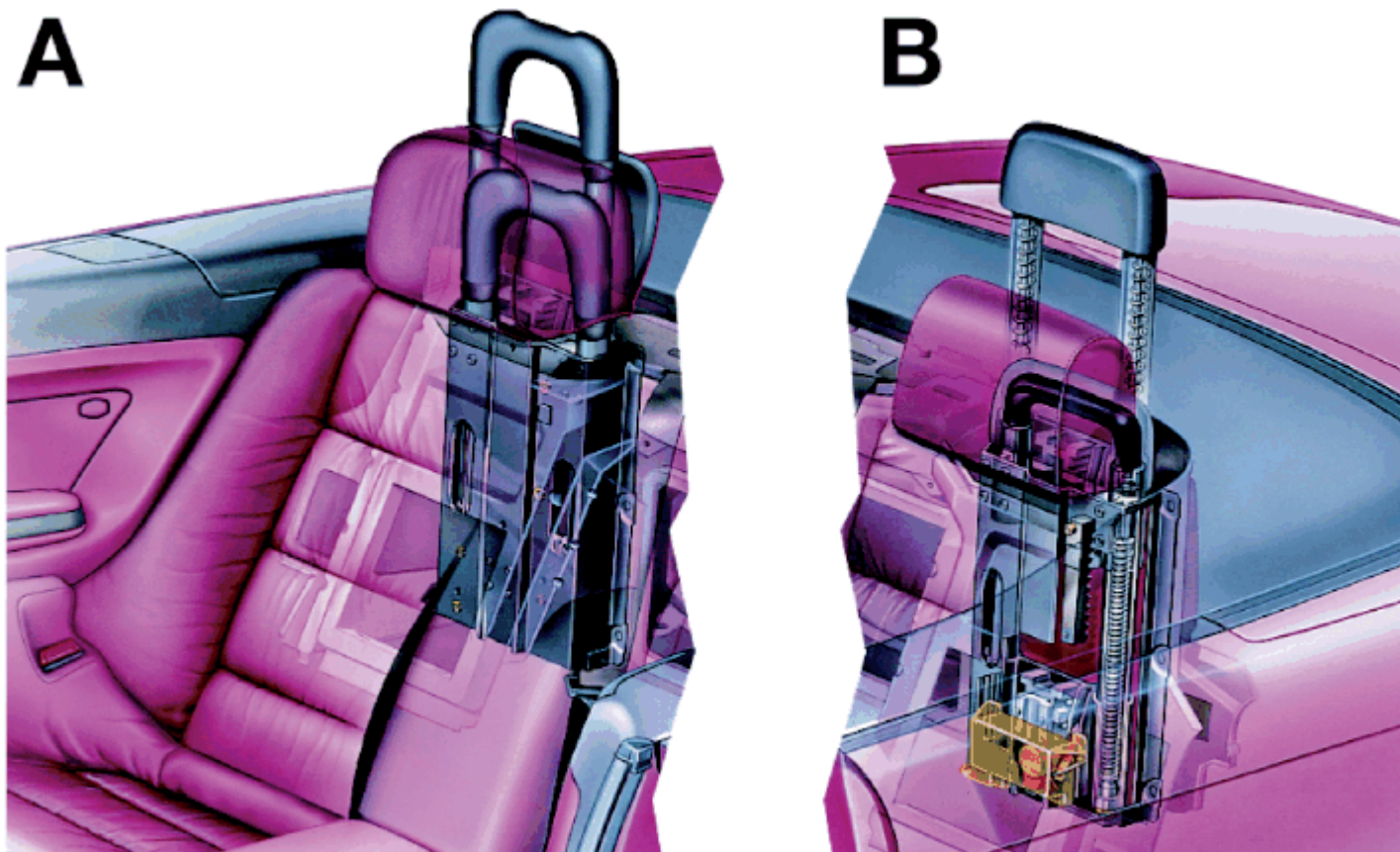

Triggered rollover protection system in the 3-Series E46 (A) and E36 (B) Convertible

On models in the 3-Series (E36), the rollover protection system comprises two rollover protection bars behind the head restraints of the rear seat (visible), and on models in the 3-Series (E46) of two rollover protection bars in the head restraints of the rear seat (installed concealed).

The rollover protection system is a separate system and is not linked to the airbag control unit.

The rollover sensor is screw-mounted directly to the protective cover behind the seat bench on the right.

The rollover sensor consists of:

- A level sensor for identification of vehicle inclination, latitudinal and longitudinal acceleration.
- An acceleration sensor for detection of loss of road contact.
- Evaluation electronics with self-diagnosis.
- Two capacitors to provide the reserve energy needed to trigger the rollover protection bars should the vehicle voltage fail.

When the limit values are reached, the integrated rollover sensor issues a command to the actuator to enable the locks. A solenoid operates the lock and releases the spring-loaded rollover protection bar. The rollover protection bars are extended and mechanically locked in their end position.

Active pedestrian protection

Active engine compartment lid

In the event of a collision with a pedestrian, the engine compartment lid is raised. This creates a deformation zone that protects the pedestrian.

Function

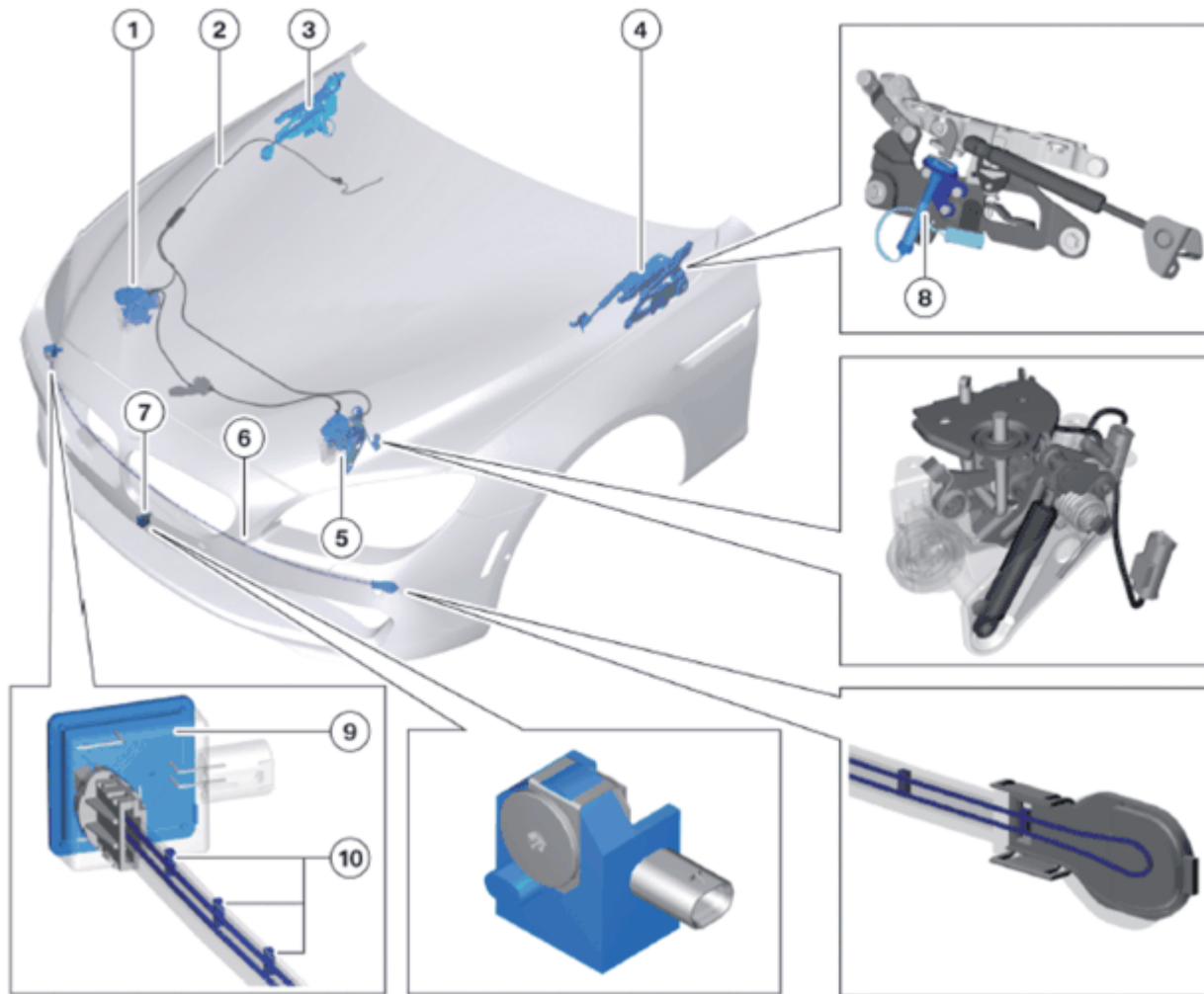

Index	Explanation
1	Bonnet catch, right (with actuator)
2	Bowden cable
3	Engine compartment lid hinge, right (with actuator)
4	Engine compartment lid hinge, left (with actuator)
5	Bonnet catch, left (with actuator)
6	Optical fibres
7	Central sensor (acceleration)
8	Actuator (on engine compartment lid hinge)
9	Sensor (optical fibre)
10	Fault structure

An optical fibre is integrated between the bumper support and impact absorber. The optical fibre is connected to a sensor and passes in a loop around to the opposite side of the vehicle before heading back to the sensor again.

A force acting on the optical fibre deforms it between the deformation structures. This causes the light in the optical fibre to be attenuated. The acting force is proportional to the light attenuation. A characteristic signal is thus generated by the differing damping action on the light, the nature of which depends on the mass and rigidity of the colliding object.

This signal is measured by the sensor and sent along a data line to the Crash Safety Module (ACSM). The Crash Safety Module ACSM uses this data and the data from the central acceleration sensor in the bumper to determine whether the threshold value for detection of an impact with pedestrians has been reached or exceeded. The ACSM consequently makes the decision to activate the actuators on the bonnet.

The actuators are activated pyrotechnically and lift the engine compartment lid. Gas pressure springs also support the engine compartment lid when raised.

The active engine compartment lid is only triggered at speeds of approx. 20 –55 km/h. For safety reasons the system may activate on those rare occasions where a pedestrian collision cannot be unequivocally ruled out, e.g.:

- a crash against a dustbin or bollard
- a collision with an animal
- hitting a rock
- driving into a snowdrift

After the active engine compartment lid is triggered, a Check Control message is shown in the instrument cluster and in the central information display.

The engine compartment lid cannot be returned to its initial position after activation. Active pedestrian protection is only re-established after a component change has been carried out. After the pedestrian protection has activated, it is only possible to continue driving carefully at a maximum speed of 80 km/h.

Body and materials

Body structure

Thanks to high-strength steels, greater wall thicknesses and a multi-shell construction, the stability of the vehicles is optimised and therefore the safety of the occupants is increased.

Modern heavy duty cutting equipment is mandatory for cutting the body. Older hydraulic cutting tools could be overloaded.

The heavy duty cutting equipment must be properly used by trained and qualified personnel.

The optimum cutting point for each vehicle has been highlighted on the emergency services data sheets.

Materials

The type and percentage proportion of each material differ for individual model ranges.

Structural reinforcements in the A- and B-pillars are primarily installed in convertibles, roadsters and coupés. This is where there are particular stability requirements on these vehicles.

Magnesium moulding

Magnesium moulding may be found in the area of the engine compartment and on the instrument panel.

Glazing

CAUTION

Glass splinters.

Danger of injury!

- Protect occupants from glass shards before removing the glass panes.

Single-layer safety glass (ESG)

Single-layer safety glass (ESG) is thermally pretreated glass that can withstand high loads. If the load is too high, however, it shatters into many fragments with not particularly sharp edges.

Single-layer safety glass is used for fixed side window glass, rear windows and the SHD.

Note:

Intact ESG window glass can jump out of position suddenly when recovery work is being performed on the vehicle. Depending on the accident situation and the scope of the rescue work, the ESG window glass should be removed first. ESG window glass can be removed by applying a pointed load, e.g. using a spring centre punch or an emergency hammer. The ESG window glass should be secured before doing so.

Laminated safety glass (VSG)

Laminated safety glass (VSG) consists of two glass panes and an interleaving plastic film. The glass panes remain largely intact when damaged.

VSG is used for windscreens and possibly for side windows. The windscreens are bonded to the body.

Note:

Since VSG window glass cannot jump suddenly out of place, it only needs to be removed if the rescue work requires it.

VSG window glass can be removed with special glass saws or hooligan tools.

Special safety glass

Some vehicles are equipped with special safety glass. It can be identified from outside by virtue of the thicker glass pane.

Special safety glass cannot be cut using conventional emergency equipment.

Electrical system - battery management

12 V batteries

Notes on usage

The procedure should be defined on the basis of the situation assessment at the scene.

The use of active electrical systems, such as power window regulators, seat adjustment or steering column adjustment, can significantly assist the rescue operation. The decision to disconnect the battery is therefore to be made by the crew leader on site.

In some cases following an accident, damaged wiring in vehicles can represent a source of ignition despite protection. Disconnection of the batteries can significantly reduce the risk of fire.

The extremely low risk of an unintentional triggering of the restraint system (airbags, belt tensioners) can be excluded by disconnecting the batteries.

The ignition must be switched off.

Position of the 12 V batteries

The vehicle may be equipped with one or two batteries.

Depending on the vehicle, the 12 V battery is located in the engine compartment or the luggage compartment.

Exception: In E34 and E32 models the 12 V battery is located in the engine compartment or below the rear seat bench.

The precise position of the 12 V battery for each vehicle has been highlighted on the emergency services data sheets.

Position of the positive battery cables

If the 12 V battery is not located in the engine compartment, the red positive battery cable mainly runs on the vehicle underbody towards the engine.

Safety battery terminal

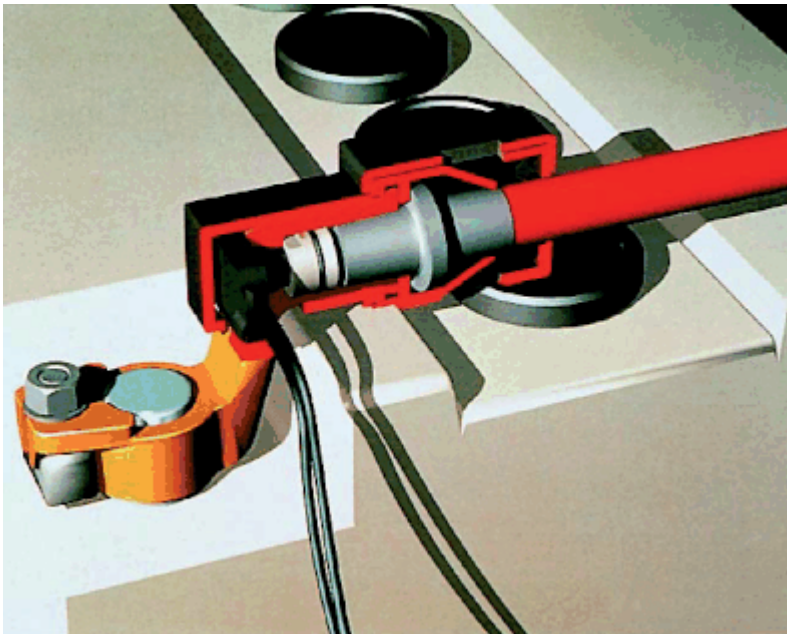

The safety battery terminal is fitted on the battery's positive terminal.

The ignition squib of the safety battery terminal must not be crushed, cut through or heated!

The safety battery terminal disconnects only the positive battery cable between the battery and starter motor/alternator.

Identification

No identification

Function

In order to minimise the risk of shorting following an accident, the vehicle electrical system in BMW vehicles is divided into two circuits: the vehicle electrical system power supply section and the starter circuit.

If the key criteria are satisfied during an accident, the airbag control unit and/or one of the satellites transmits the command to activate the propellant charge in the safety battery terminal. The gas volume this produces slides the cable pin out of the battery terminal bracket, thereby disconnecting the plug connection between the battery and starter motor/alternator.

The other consumers continue to be supplied with voltage by their own connection to the battery (vehicle electrical system power supply section).

The entire triggering process lasts approximately 3 milliseconds.

Disconnecting batteries

When disconnecting batteries the following must be complied with:

- Switch off ignition.

- Firstly disconnect the negative terminal, then the positive terminal.
- If two batteries are installed, always disconnect **both** batteries.

Note: Mechanical belt tensioners cannot be deactivated by disconnecting the battery.

Attention: If the vehicle cannot be de-energised:

- Do not remain in the area in which the triggered airbag may unfold and do not place material in this area if heavy emergency equipment is being used.
- Wherever possible, treat casualties from the side.

High-voltage batteries

High-voltage batteries have a voltage of 60 V to 1000 V.

For detailed information on each vehicle see the emergency services data sheet.

- ActiveHybrid 7 F04, F01, F02 see 7 Series Saloon emergency services data sheet
- ActiveHybrid 5 F10, see 5 Series Saloon emergency services data sheet
- 530 Le F18PHEV, see 5 Series Saloon emergency services data sheet
- ActiveHybrid 3 F30, see 3 Series Saloon emergency services data sheet
- X5 F15PHEV, see X5 off-road vehicle emergency services data sheet
- X6 ActiveHybrid E72, see X6 off-road vehicle emergency services data sheet
- BMW Active E, E82, see 1 Series emergency services data sheet
- MINI E, see MINI E emergency services data sheet
- BMW eDrive, see I01, I12 emergency services data sheet

For further detailed information on high-voltage technology, see rescue manual.

Alternative Antriebe

Elektrofahrzeuge

Detaillierte Informationen zu MINI E, siehe Rettungsdatenblatt MINI E.

Detaillierte Informationen zu BMW Active E, siehe Rettungsdatenblatt 1er.

Detaillierte Informationen zu BMW eDrive, siehe Rettungsdatenblatt I01, I12.

Hybrid-Fahrzeuge

Detaillierte Informationen zu ActiveHybrid 7 F04, F01, F02, siehe Rettungsdatenblatt Limousine 7er.

Detaillierte Informationen zu ActiveHybrid 5 F10, F18 PHEV siehe Rettungsdatenblatt Limousine 5er.

Detaillierte Informationen zu ActiveHybrid 3 F30, siehe Rettungsdatenblatt Limousine 3er.

Detaillierte Informationen zu X5 F15 PHEV, siehe Rettungsdatenblatt SAV X5.

Detaillierte Informationen zu X6 ActiveHybrid E72, siehe Rettungsdatenblatt SAV X6.

Detaillierte Informationen zum G11/ G12 PHEV, siehe Rettungsdatenblatt Limousine 7er.

Detaillierte Informationen zum G30 PHEV, siehe Rettungsdatenblatt Limousine 5er.

Detaillierte Informationen zum G38 PHEV, siehe Rettungsdatenblatt Limousine 5er.

Detaillierte Informationen zum F60 PHEV, siehe Rettungsdatenblatt Mini Countryman.

Detaillierte Informationen zum F45 PHEV, siehe Rettungsdatenblatt Kombilimousine 2er.

Detaillierte Informationen zum F30 PHEV, siehe Rettungsdatenblatt Limousine 3er.

Weitere detaillierte Informationen über alternative Antriebe siehe Rettungsleitfaden.

Kraftstoffe und Kraftstoffbehälter

Kraftstoffe

Dieselmotor: Dieselmotorkraftstoff DIN EN 590

Benzinmotor:

- Super Plus, 98 ROZ
- Super Plus, 98 ROZ
- Normalbenzin bleifrei, 91 ROZ

Kraftstoffbehälter

Der Kraftstoffbehälter befindet sich im Bereich der Hinterachse am Fahrzeugunterboden.

Ausnahme: Bei den Modellen E32 und Limousine E34 befindet sich der Kraftstoffbehälter im Bereich des Gepäckraums.

Die genaue Lage des Kraftstoffbehälters für das jeweilige Fahrzeug ist im Rettungsdatenblatt eingezeichnet.

Tankklappe

BMW: Die Tankklappe befindet sich auf der rechten Seite.

MINI: Die Tankklappe befindet sich auf der linken Seite.

Die genaue Lage der Tankklappe für das jeweilige Fahrzeug ist im Rettungsdatenblatt eingezeichnet.

Frequently asked questions about the airbag system

How does an airbag work?

The acceleration recorded by the sensors is integrated and evaluated. Once the corresponding triggering thresholds are exceeded, the required airbags are triggered. The ignition squib in the gas generator obtains the ignition voltage from the airbag control unit and/or relevant satellite. The gas produced escapes into the airbag.

How do I identify whether a vehicle is fitted with airbags?

"AIRBAG" or "SRS" or "SRS-AIRBAG" labelling on the steering wheel, instrument panel, door trim panel and A-pillar trim panel, C-pillar, outer side of the backrest of the driver's and front passenger seats. If in any doubt, assume that newer vehicles are equipped with an airbag.

Is smoke emitted during ignition?

Generally dust is produced from the talcum powder applied to the airbag in the factory.

Does the airbag heat up?

The airbag does not get hot. Only the components inside the airbag module reach high temperatures after triggering. These components are near the airbag attachment and do not pose a risk to the emergency services. The parts need approximately 15 minutes to cool down.

Does the residue contain sodium azide?

Sodium azide, the solid propellant in the gas generator, combusts totally when the gas generator is ignited and is totally chemically converted. The product of the reaction is mainly safe nitrogen gas which makes up approximately 80 % of the air we breathe.

What precautions must be taken if an airbag module is mechanically damaged but has not been activated?

In the extremely unlikely event that the airbag gas generator has been destroyed, the propellant (pressed into tablet form) could fall out. If this happens, avoid contact with the skin at all costs (wear gloves and safety goggles). The tablets must be treated and disposed of separately. They must be kept away from any source of ignition (electricity, fire etc.).

If the vehicle catches fire, is there a risk of the gas generator exploding?

The gas generator has been designed so that it will be triggered normally when exposed to fire if the surface temperature of the gas generator exceeds 200 °C.

Can water be used as an extinguishant?

Yes. Any effective fire-extinguishing agent can be used, even in vehicles equipped with airbags.

Is it safe to inhale the air in the vehicle interior after airbag deployment?

Yes. Chemical and medical analyses confirm that it is totally safe. You may however experience a tickly throat for a short period.

If the airbag was not activated during the crash, is there a chance that it will activate after the crash?

No. The impact sensors respond to unique physical properties of an accident.

Are first-aiders putting themselves at any risk?

No. A first-aider (a helper without emergency equipment) will find the same situation as in normal driving. If the vehicle is stationary, the airbag systems are not triggered.

If the airbag has not been activated during the crash, how can the system be deactivated?

Switch off ignition. Disconnect both battery cables (first the negative terminal and then the positive terminal) from the battery.

This rules out the risk of the airbag triggering during the rescue. For exceptions, refer to the "Airbag" section.

Is it advisable for emergency services to postpone rescue efforts until the airbag system has been deactivated?

No. Switch off ignition. Disconnect both battery cables (first the negative terminal and then the positive terminal) from the battery.

If the points raised in "Response of the restraint and safety systems after an accident" are noted emergency aid can be given to the occupants straight away.

What is the procedure if persons are trapped, individual airbag systems have not been activated and it is not possible to de-energise the vehicle?

- Administer emergency medical aid immediately.
- Create support openings as a priority.

- Test: which untriggered airbag systems does the vehicle have and where are they in relation to where the emergency service and recovery helpers are working?
- If at all possible, do not pull the steering column with the spreader.
- Do not cut through any cables near the airbag systems (this will result in a small risk of the airbag deployment by a short circuit)
- Deployment radius of an untriggered airbag: Initiate protective measures for injured persons.
- Attend to casualties from the side.
- Wherever possible, do not move your head or upper body into the area in which the airbag operates when work is being carried out on the vehicle with heavy emergency equipment.
- Do not remain in the area in which the untriggered airbag may unfold and do not place material in this area if heavy emergency equipment is being used.

Are other rescue methods suitable?

Yes, the final decision on the procedure for the rescue always lies with head of operations, the technical emergency team and the emergency doctor or emergency services staff on site. They must reach agreement on how to proceed. They must reach agreement on how to proceed. The technical and tactical possibilities open to them, details of the accident and extent of vehicle destruction must also be taken into account.

High-voltage / hybrid technology



BMW i - the safety of the eDrive is an essential element of all BMW i vehicles

The safety of the eDrive is an essential element of product development. A variety of measures safeguard operating safety, including in the event of accidents.

- Fully insulated high-voltage system.
- Automatic safety cutout (disconnection) of the high-voltage battery in the event of an accident with airbag activation.
- Permanent monitoring of the high-voltage cables and other safety-relevant criteria, as well as automatic safety processes.

All systems have demonstrated their safety in crash tests and standard checks. The BMW system tests have demonstrated system safety at a level that exceeds the statutory requirements.

What does "high-voltage system" mean in the vehicle?

In vehicles with high-voltage systems, components are installed that are operated with voltages above 60 V direct current voltage or 25 V AC voltage. Some components in these vehicles need high electrical powers. The high-voltage electrical system in hybrid cars and electric vehicles operates with direct current voltages of up to 650 V and has to provide large amounts of electrical energy.

Which components make up a hybrid car?

In addition to the drive unit, a hybrid car is made up from the following fundamental components:

- High-voltage battery
- High-voltage cables
- Electrical machine electronics
- Electric motor(s) and alternator(s)

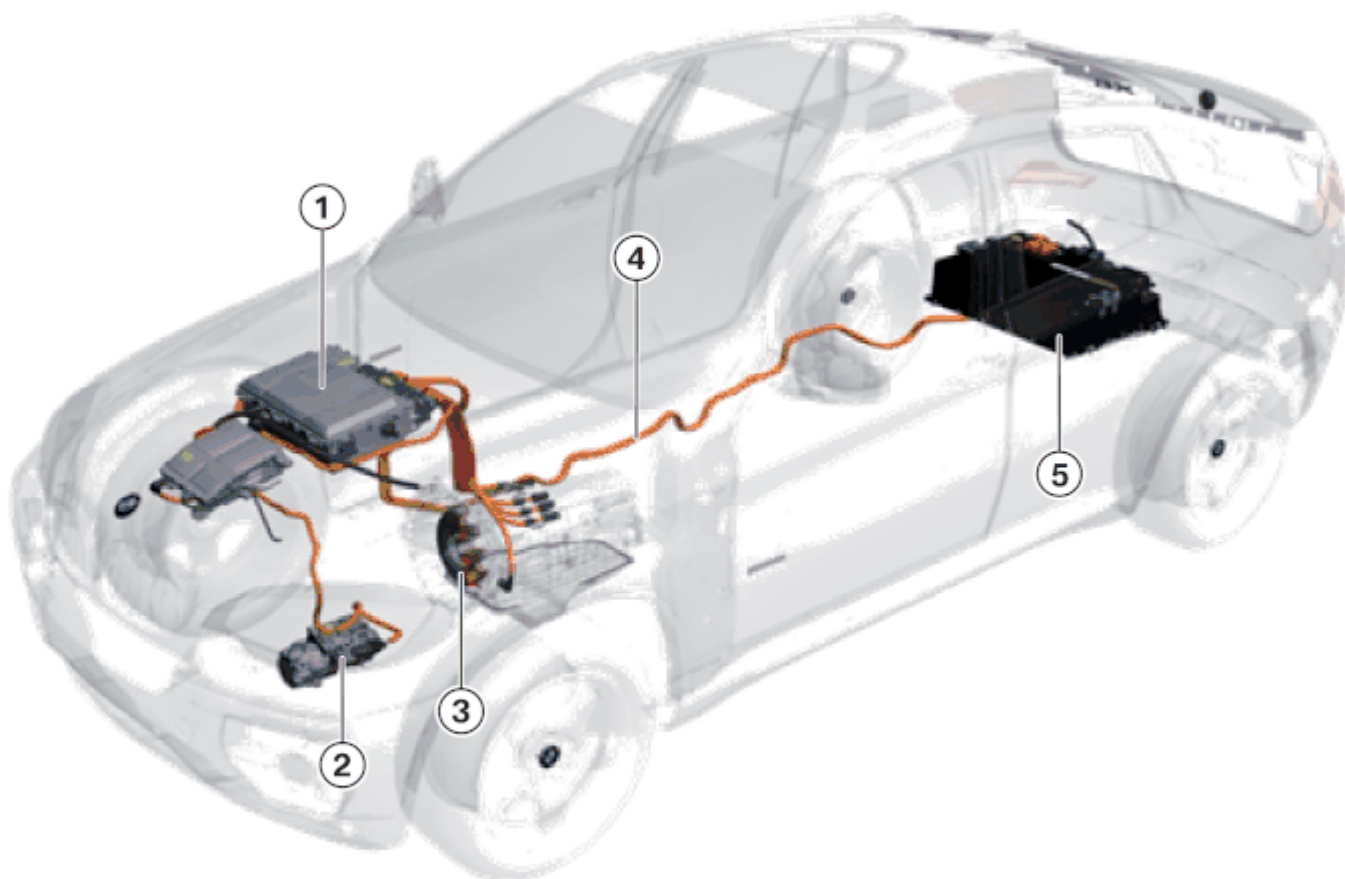

High-voltage component overview based on the example of the X6 ActiveHybrid E72:

Index	Explanation
-------	-------------

Index	Explanation
1	Electrical machine electronics
2	Electrical refrigerant compressor
3	Active transmission with electric motors/alternators for full hybrid
4	High-voltage cables
5	High-voltage battery

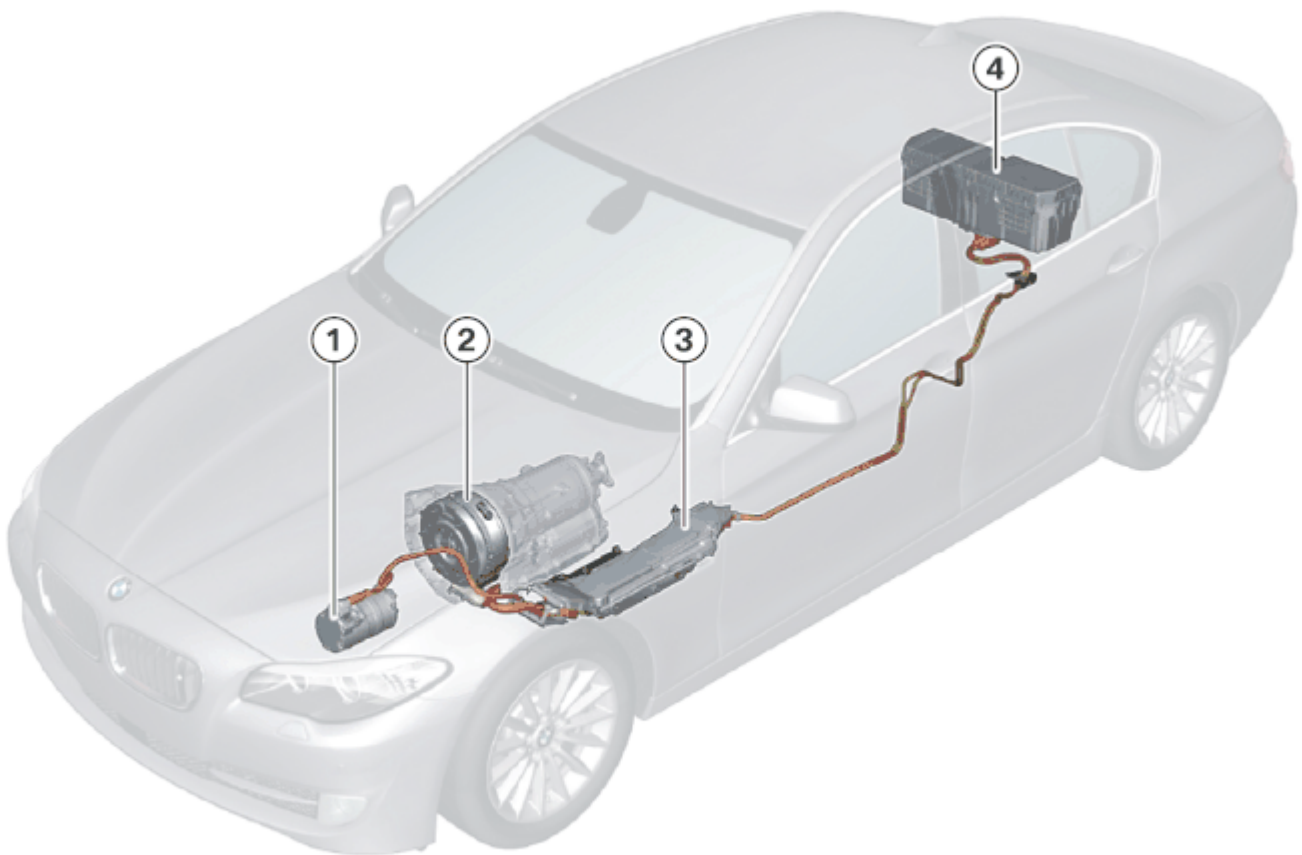

High-voltage component overview based on the example of the 3 Series active hybrid 3 F30:

Index	Explanation
1	Electrical refrigerant compressor
2	Electric machine
3	Electrical machine electronics
4	High-voltage battery

High-voltage safety

With improper use, the high voltage in the high-voltage system may become a source of danger. The vehicle therefore has a comprehensive safety concept. Only technicians who have been appropriately trained are permitted to carry out the repair, maintenance and servicing of high-voltage components including the orange-coloured high-voltage cables.

Unauthorised repair work on the high-voltage system is forbidden.

Further information on high-voltage safety:

- The high-voltage battery is located in the crash-protected area. See emergency services data sheet for details.
- The high-voltage system is deactivated (de-energised) by disconnecting the plug connection of the high-voltage rescue separation point.
- The high-voltage system is galvanically isolated from GND.
- All connections and connectors on the vehicle high-voltage components are designed to be safe to touch.

The high-voltage system is switched-off when:

- **the plug connection of the high-voltage rescue separation point is disconnected**
- **a crash is identified that causes a triggering of airbag and/or belt tensioner, or**
- **the 12 V battery negative connection is disconnected from the negative battery terminal**

High-voltage battery including high-voltage rescue separation point

Example X6 Active HybridE72

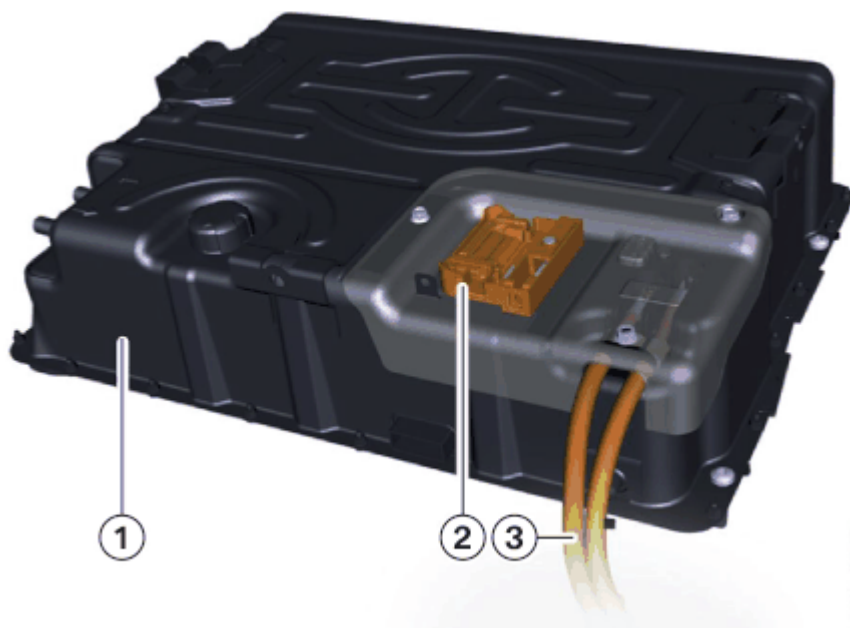

Index	Explanation
1	High-voltage battery
2	High-voltage emergency separation point
3	High-voltage cables

Example of a 3 Series active hybrid 3 F30:

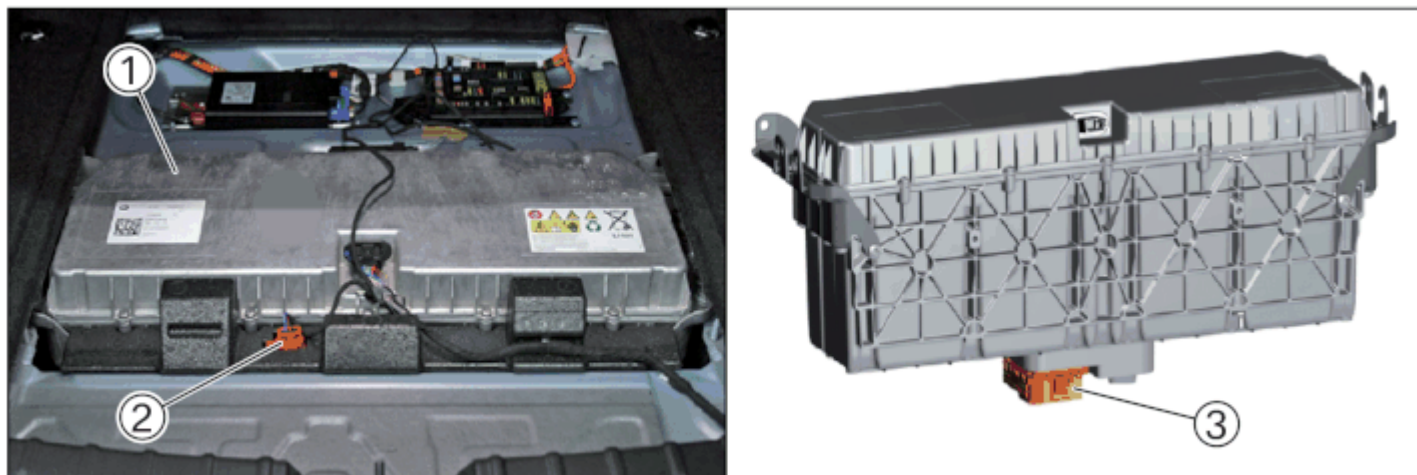

Index	Explanation
1	High-voltage battery
2	High-voltage emergency separation point
3	Plug connection for high-voltage cable

The high-voltage rescue separation point plays a crucial role in vehicle manufacturer safety concepts. Its function is always the same, i.e. to interrupt the circuit between the high-voltage battery and the vehicle. The circuit outside the high-voltage battery and therefore the entire high-voltage system is interrupted immediately when the plug connection of the high-voltage rescue separation point is removed.

Electrical machine electronics

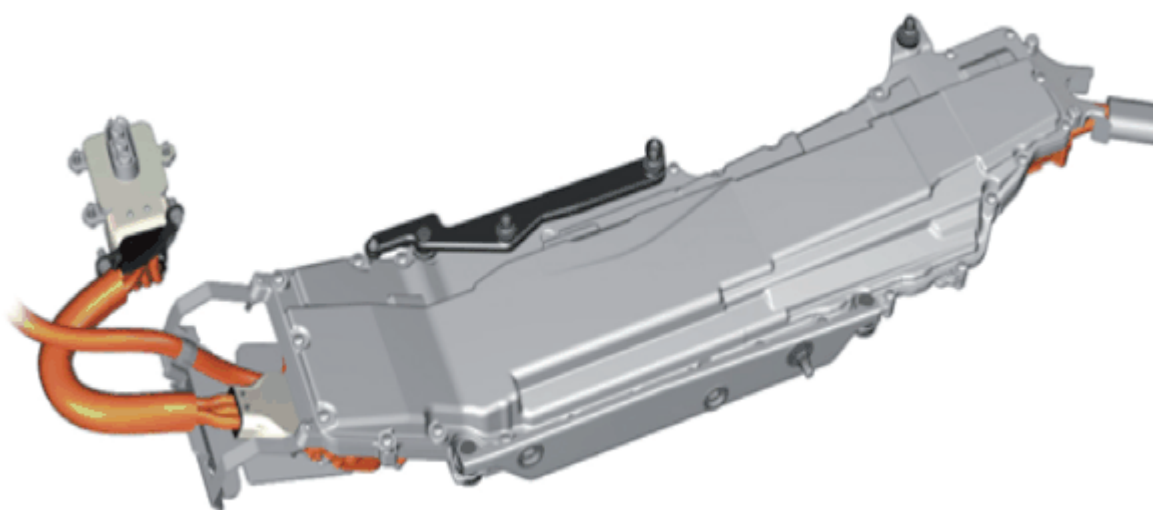

In hybrid technology, electrical machine electronics are used to convert currents. The electrical machine electronics are called an inverter. It converts alternating current generated in the high-voltage alternator into direct current. As with all other high-voltage components, the inverter is not to be opened in any circumstances as high voltages are applied internally.

Electric machine



The electrical machine in the ActiveHybrid 5 is a permanently excited synchronous machine. It can convert the electrical energy from the high-voltage battery into the kinetic energy that drives the vehicle. Driving with electrical power up to approximately 60 km/h as well as support to the combustion engine, e.g. when overtaking (boost function), or active torque support during gear change are possible.

Conversely, during braking and in coasting (overrun) mode the electrical machine converts kinetic energy into electrical energy and feeds it into the high-voltage battery (energy recovery).

High-voltage cables



Further information:

It is mandatory to consult the respective **emergency services data sheet** for vehicle-specific information and the procedure for vehicles involved in accidents.

First aid & recovery of vehicles with high-voltage systems according to the German Association of the Automotive Industry)

First aid & recovery of vehicles with high-voltage systems according to the German Association of the Automotive Industry)

FAQ (Frequently Asked Questions)

Structure

- 1 Investigation/vehicle identification
- 2 Risk of electric shock
- 3 Risk caused by high-voltage energy storage unit
- 4 Chemical risk
- 5 Thermal risk (fire)
- 6 Electrical charging infrastructure
- 7 Vehicles in water
- 8 Towing away, recovery, transport, BMW breakdown assistance and safekeeping
- 9 Further information

1. Investigation/vehicle identification

1.1 How can I identify if the vehicle concerned features a high-voltage system?

The type designations on the rear of the vehicle, such as hybrid, eDrive or other labelling, e.g. on the front side panel or similar may provide indication.

If the vehicle does not feature any such type designation, the following characteristics may indicate a vehicle with high-voltage system:

- Electrical charging socket

- Orange coloured high-voltage cables
- Warning sticker on electrical high-voltage components
- Charging symbol in the instrument cluster
- Identification on the instrument panel
- No exhaust system

However, if the vehicle does not feature such identification, this does not clearly indicate that this is a vehicle without high-voltage system.

From January 2013 on, vehicle number plate requests for vehicles registered in Germany have been possible for German emergency control centres to allow clear allocation with the corresponding emergency services data sheet.

2. Risk of electric shock

2.1 Is there a risk of electric shock upon coming into contact with the vehicle or vehicle components following an accident?

The danger of an electric shock is principally not present. However, this depends on the type of the accident.

The vehicles are equipped with several, differing protective mechanisms.

- The high-voltage system is designed to be touch-protected.
- The high-voltage system is fully electrically insulated from the vehicle body (galvanic/electrical isolation).
- In the majority of vehicles the high-voltage system is switched off in the event of severe accidents involving airbag deployment. Alternatively, comparable protection mechanisms are fitted. (for details see vehicle-specific emergency services data sheet)

In case of doubt, the high-voltage system of the vehicle should be deactivated manually where possible (see question 2.4).

2.2 Is it possible to identify whether the high-voltage system has been switched off in electric/hybrid vehicles involved in an accident?

Immediate display of the de-energisation of the system after an accident is not possible due to the variety of potential damage scenarios.

In case of doubt, the high-voltage system of the vehicle should be deactivated manually where possible (see question 2.4).

2.3 Is there a risk of electric shock caused by parked vehicles that are involved in an accident (crash when stationary)?

The high-voltage system of the vehicle can also be active during standstill (for example stationary cooling).

Airbag deployment will normally not occur for high-voltage vehicles that are involved in a "stationary crash". Thus, the high-voltage system cannot be switched off by this either.

In the event of a serious accident, the vehicle's high-voltage system must therefore be deactivated (see emergency services data sheet).

This applies for both, vehicles at an electrical charging station and parked vehicles that are not connected to a charging station.

2.4 Can emergency service personnel manually deactivate a high-voltage system?

Yes, electric/hybrid vehicles feature various options to manually deactivate the high-voltage system.

The majority of vehicles feature an additional deactivation unit for the high-voltage system which is available to emergency service personnel. These switch-off devices are called 12 volt separation points. These separation points can also be operated by personnel who are not high-voltage specialists to deactivate the high-voltage system. **Note:** The high-voltage battery pack is not discharged by this process – but it is electrically separated from the high-voltage system.

The recommended procedure for manual deactivation is described in the emergency services datasheet of the corresponding manufacturer.

2.5 Which risks are posed by damaged high-voltage cables following an accident if it has been identified that airbags have not been activated?

As a rule, damaged high-voltage cables or high-voltage components represent an electrical hazard. Do not touch high-voltage cables and high-voltage components. **Note:** High-voltage cables are always orange.

3. Risk caused by high-voltage energy storage unit

3.1 Can the energy in high-voltage energy storage units discharge following an accident?

No, electrical discharging of the high-voltage battery pack is not practical at the scene of an accident.

3.2 What is the procedure to handle damaged high-voltage energy storage units in the vehicle at the scene of an accident?

- Never touch a damaged high-voltage battery pack.
- Observe the state of the high-voltage battery pack (for example, smoke formation).

Qualified electrical specialists must be requested via the central control centre to assess the specific electrical danger and determine how to proceed.

3.3 What is the procedure to handle high-voltage energy storage units or parts thereof that have been disconnected or loosened from the vehicle in an accident?

In the very unlikely event of this occurring, you should be aware of the possibility of electrical, chemical, mechanical and thermal risks from the high-voltage battery pack.

Never touch the high-voltage battery pack.

Qualified electrical specialists must be requested via the central control centre to assess the specific electrical danger and determine how to proceed.

4. Chemical risk

4.1 What is important when handling electrolyte that is escaping from high-voltage energy storage units following an accident?

Electrolytes are usually irritants, combustible and potentially corrosive. Prevent any skin contact and do not inhale the vapours.

Conventional binders are to be used.

4.2 What are the risks during the "gas emission" process in high-voltage energy storage units?

In the immediate vicinity, gases are irritants, combustible and potentially corrosive and should not be inhaled under any circumstances.

The recovery process must be halted and further procedures coordinated with the head of the fire service.

5. Thermal risk (fire)

5.1 Are explosions of the high-voltage energy storage unit likely in the event of a fire?

Thanks to appropriate safety technology, the risk of explosion of high-voltage battery packs is totally eliminated.

The high-voltage battery and its individual battery cells have mechanical safety fittings, which open, for example, in the event of temperature and pressure increase relating to a fire, thus leading to targeted degassing and pressure reduction.

5.2 Does toxic smoke develop as a result of a fire of the electric//hybrid vehicle?

Yes, in the event of an electric or hybrid car fire, as well as a conventional vehicle fire, hazardous smoke should be expected from burning materials such as plastics.

5.3 Can the high-voltage energy storage unit catch fire at a later point in time after an accident?

Yes, as with conventional vehicles which have been involved in an accident, the residual risk of a delayed fire cannot be ruled out. This particularly applies to damaged high-voltage battery packs (see also question 8.5).

5.4 Are vehicles with high-voltage energy storage units safe to extinguish in the event of a fire and which extinguishant must be used?

In general, yes.

Water represents the preferred extinguishant as it also cools the high-voltage battery. The use of lots of water to extinguish and/or cool is recommended.

6. Electrical charging infrastructure

6.1 What must be taken into account if an electric/hybrid vehicle that is connected to a charging station is involved in an accident (crash when stationary)?

If possible, pull off the charging cable from the charging station/vehicle or switch off the charging station. The charging cable must always be disconnected from the vehicle.

Visually check cables and connectors for possible damage before removing them.

In the event of a **serious** accident, the vehicle's high-voltage system must be deactivated (see emergency services data sheet).

Note: The vehicle's high-voltage system can be active when stationary (e.g. stationary cooling), independently of the charging station.

6.2 What are the effects of cutting and hence vandalising a charging cable on a public charging station during the charging procedure of an electric vehicle?

The technical infrastructure of the public charging station has safeguards for this scenario and the charging procedure is generally switched off.

The operator of the public charging station should be informed.

7. Vehicles in water

7.1 Are there specific risks with electric/hybrid vehicles in water?

The notes as described in sections 2 and 3 apply.

The procedure for recovery is identical to conventional vehicles.

This also applies for bodies made of carbon fibre composites.

7.2 Is there a water contamination risk in areas affected by drinking water protection regulations (e.g. dam) if an electric/hybrid vehicle comes into contact with this body of water?

Compared with conventional vehicles, there is normally no additional danger for the drinking water.

8. Towing away, recovery, transport, BMW breakdown assistance and safekeeping

8.1 What must be taken into account if an electric/hybrid vehicle is removed from a danger area (e.g. motorway roadworks) using a tow cable/towbar?

The removal of the vehicle from the immediate danger area **with a walking speed** is in principle always permitted.

Further information on towing away can be obtained from the Owner's Handbook of the vehicle manufacturer.

8.2 What must be taken into account when (un)loading an electric/hybrid vehicle after a serious accident?

The high-voltage system should be deactivated before loading. Notes on this can be found in the Owner's Handbook for the vehicle or in the emergency services datasheet.

In the event of transfer to the authorities representative / recovery company, it is recommended that these are informed of the measures carried out by the fire service (high-voltage deactivation). Specifically, they must be informed of the potential danger from damaged high-voltage components (e.g. electric shock or risk of fire from the battery pack).

National regulations / standards for loading and transport must be observed (in Germany: BGI 800 and BGI 8664, BGI 8686 and BGI 5065).

If the vehicle is transferred to third parties, it is recommended to communicate and confirm in written forms the measures carried out.

When lifting the vehicle with a crane/jack or when loading it, it is recommended to keep in mind the following:

When working with a winch, make sure that no high-voltage components are/were damaged.

8.3 What must be taken into account when transporting/towing away electric/hybrid vehicles involved in accidents?

The vehicle should always be transported on a flatbed trailer or in accordance with the manufacturer's stipulations.

When towing away in a hoisting frame, damages to the electrical/hybrid system may occur when the driving axle(s) remain/remains on the street. Note: Be aware of vehicles with four-wheel drive!

Where possible, vehicles with damaged batteries should be transported to the nearest suitable BMW authorised workshop or to a safe place of storage (see also question 8.5).

8.4 Are there regulations which restrict passing through tunnels if accident recovery vehicles are carrying damaged electric/hybrid vehicles?

No, the rules of the ADR do not apply to battery-powered vehicles and hybrid cars.

(**A**ccord européen relatif au transport international des marchandises **D**angereuses par **R**oute - European Agreement For the International Carriage of Dangerous Goods by Road)

In consideration of previous measures (see 8.2) and the degree of damage, the recovery company must ensure the road safety of the transport. Be aware of the potential risks from damaged high-voltage components (e.g. electric shock or risk of fire from the energy storage units).

Country- and operator-specific tunnel regulations are to be observed.

8.5 How are electric/hybrid vehicles that were involved in accidents parked and stored correctly?

For reasons of fire safety, electric or hybrid cars should be parked just like conventional vehicles in a closed-off area of an **outdoor parking area** with sufficient clearance to other vehicles, buildings and combustible objects.

The vehicle should be marked accordingly.

This is particularly important if the vehicle is delivered to the site outside of working hours.

9. Further information

The following rule has proved useful in helping the fire service identify alternative drive technology:

A = Leaking operating fluids

U = Check vehicle underbody

T = Open fuel filler cap

O = Check surface

The most updated version of the FAQ (Frequently Asked Questions) of the German Association of the Automotive Industry can be found here: http://www.vda.de/en/publikationen/publikationen_downloads/detail.php?id=1200

Additional notes on electrical hazards at fires are described in BGI/GUV-I 8677 (governing electrical hazards at fires).

I01 expert guide



1 Introduction

This guide is to be followed after a severe accident when the emergency service personnel is in doubt about the state of the high-voltage system.

Always observe country-specific guidelines.

In case the intrinsic safety of the vehicle is suspected not to be present any longer and a dangerous situation for the emergency service personnel is to be assumed, a qualified electrical specialist needs to be consulted.

In case of severe accidents with the risk of damage to the high-voltage battery being present, the high-voltage battery is automatically disconnected from the high-voltage system.

Prior to any further work on the vehicle (e.g. repair, recycling), an inspection must be carried out by suitably qualified personnel, according to the BMW specification.

The high-voltage system is generally to be considered intrinsically safe. In the event of an airbag deployment, there are two switch-off mechanisms in the vehicle that switch off the high-voltage system. Firstly, the system is switched off by blowing off the safety battery terminal from the 12V positive terminal of the battery. Secondly, by a CAN message which disconnects the voltage supply of the battery switch contactors in the high-voltage battery and switches off the system. The high-voltage system (IT system) consists of two separate circuits (HV+, HV-), which are completely decoupled from the 12 V vehicle electrical system. The electrical GND (-) has no high-voltage potential. Only the housings of the components are connected to GND to allow potential compensation. In order to provoke electrical damage, a person needs to be in-between the positive and the negative HV circuit. If no damaged high-voltage cables (orange-coloured lines) or high-voltage components are touched, an electric shock cannot occur under any circumstances.

Attention: The instructions described in the following are intended for use exclusively on the BMW I01.

2 Essential information

2.1 Definition of a severely damaged vehicle

A vehicle is to be considered severely damaged if at least one of the following preconditions are met:

- Intrusions or deformation of more than 5 millimetres at the housing of the high-voltage battery
- Vehicle is completely or partially under water (for example harbour basin, river, channel system)
- Vehicle completely or partially on fire

3 Rescue & Recovery

3.1 Securing the high-voltage system

Disconnect the plug connection of the high-voltage rescue isolation point and disconnect the 12 V battery (negative terminal) to switch off the high-voltage system (see emergency services data sheet for procedure). In case of airbag deployment, the switch-off of the high-voltage system can be assumed. Touching high-voltage components and high-voltage cables is to be avoided. Ground straps (potential compensation) of the high-voltage components may not be cut through. The de-energised state can be read off from the instrument cluster (12 V battery must still be connected) or determined by a qualified electrician using defined measurements.

3.1.1 Deactivating the high-voltage system (de-energising)

The high-voltage rescue separation point and the 12 V battery are located underneath the engine compartment lid.

Disconnect the plug connection of the high-voltage rescue isolation point and disconnect the 12 V battery (negative terminal) to deactivate the high-voltage system (see emergency services data sheet).

If the high-voltage rescue separation point underneath the engine compartment lid cannot be accessed, the switch-off of the high-voltage system can also be carried out via the large high-voltage connectors at the electrical machine electronics located in the luggage compartment underneath the service cap.

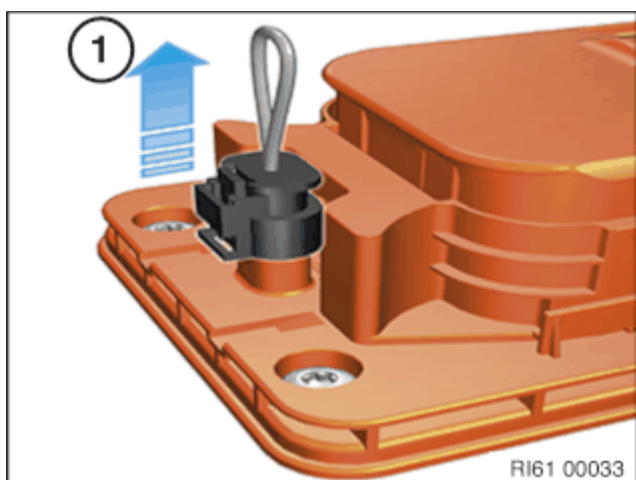

The high-voltage system can be switched off by removing (1) the small pole connector. See following chapter, point 7.

3.1.2 De-energising the system

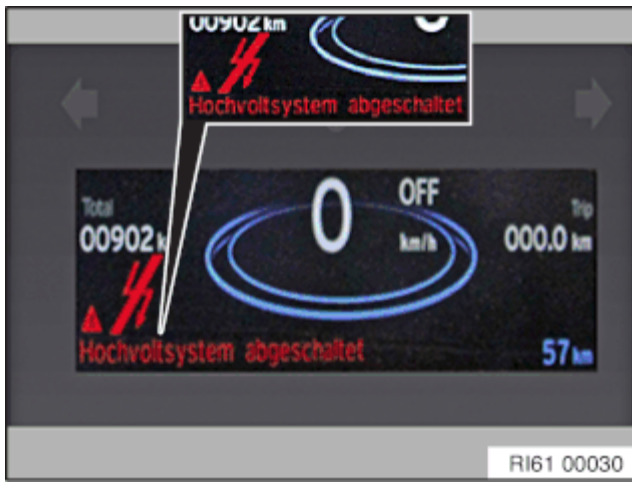

A switched off high-voltage system can be identified via the Check Control message "High-voltage system deactivated" in the instrument cluster.

Note: Connect the 12 V battery and carry out a terminal change (switch the vehicle off and on again using the start/stop button) to display the information.

If the de-energised state cannot be identified by means of the instrument cluster, the state can be identified by a qualified electrical specialists with personal protective equipment via the following measurements.

Operations:

1. Switch off vehicle. Put vehicle in passive state via START-STOP button.
2. Remove vehicle key
3. Open tailgate.
4. Disconnect the 12 V battery.



5. Remove luggage compartment floor cover.

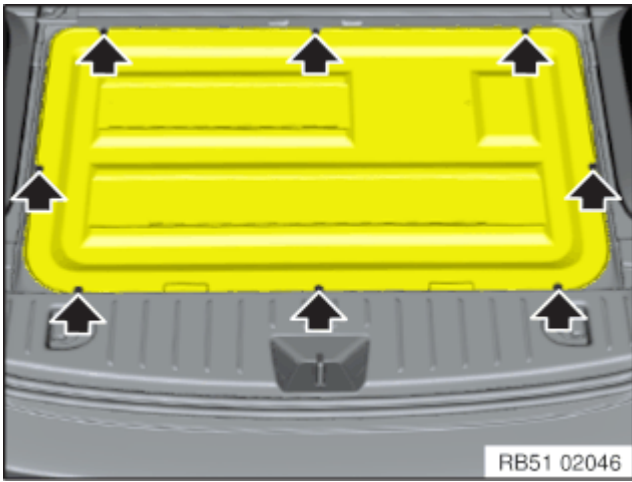

6. Remove service cap. Release 8 screws (arrows) and take out the engine compartment cover.



The electrical machine electronics (1) are located on the left below the opening with the electrical machine underneath and the range extender (2) on the right-hand side (if installed).



7. Disconnect high-voltage connector.

Push locking at pole connector (1) of the high-voltage connector (2) and remove pole connector (1).

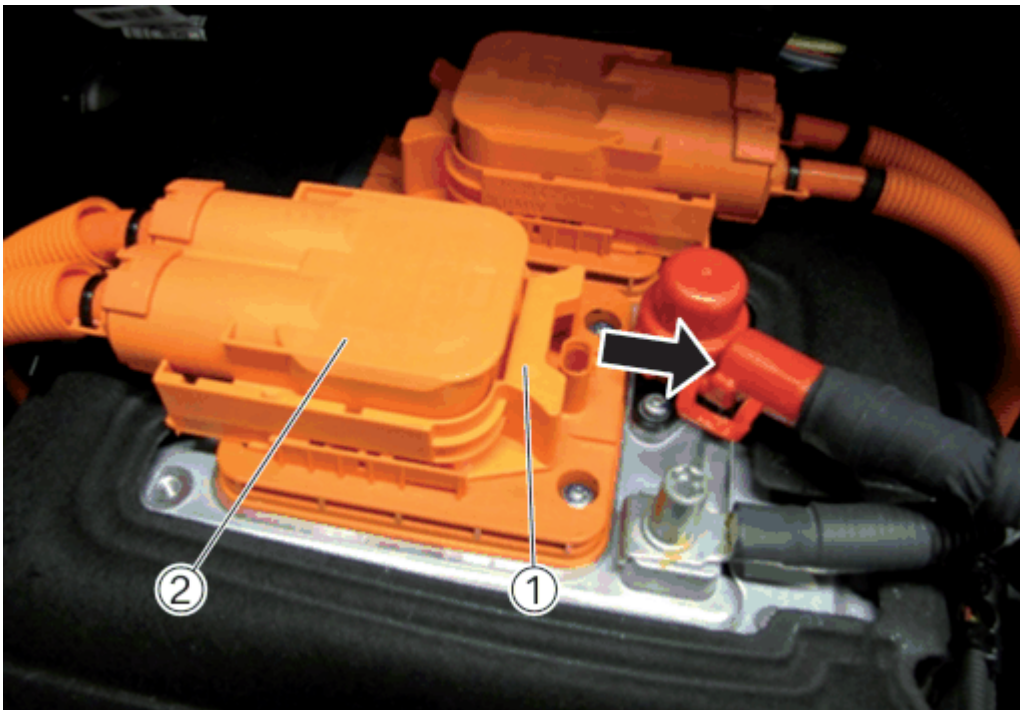

Pull out locking (1) of the high-voltage connector (2) in direction of arrow until the limit position is reached.

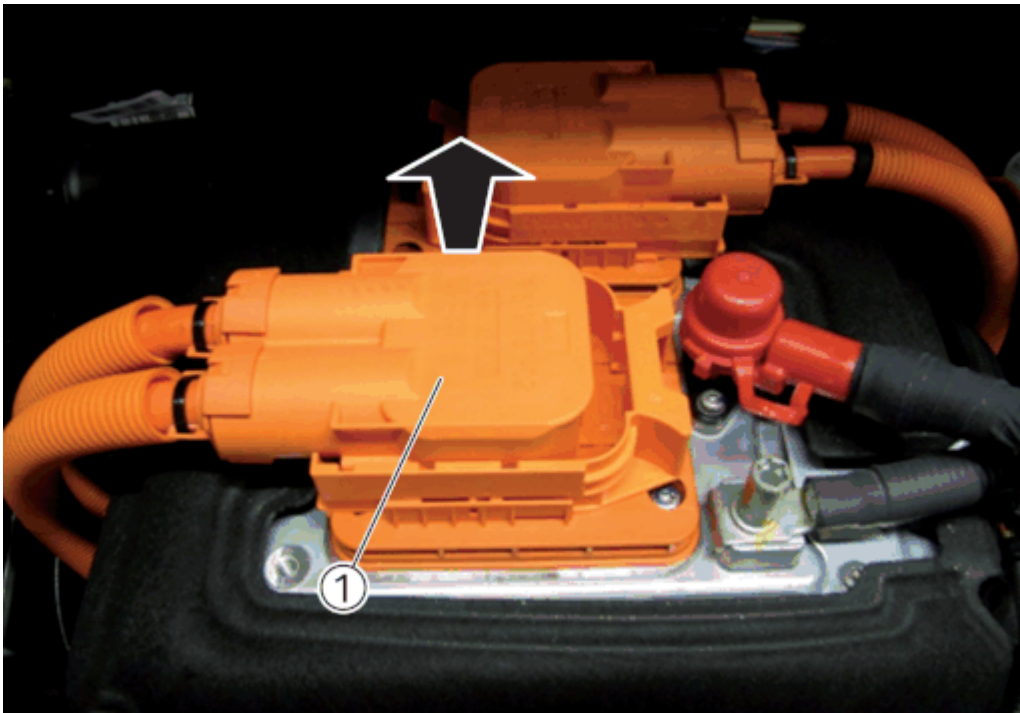

Pull off high-voltage connector (1) upwards.

8. Measuring the de-energised state at the high-voltage connector.

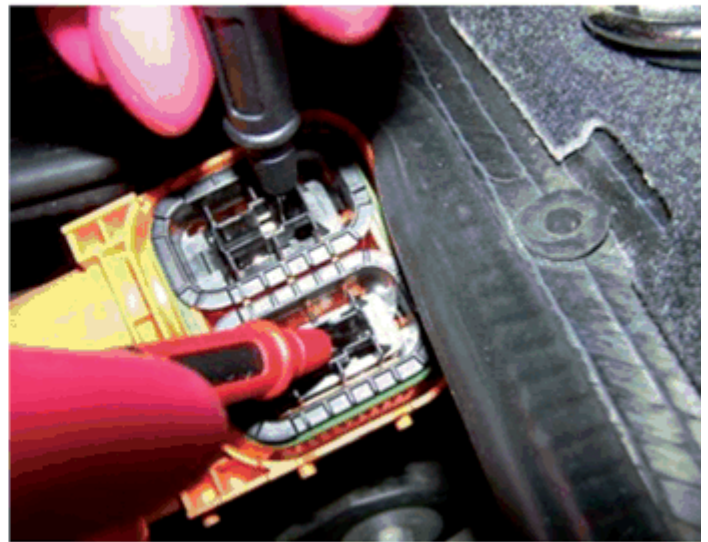

The disconnected high-voltage cable is directly linked to high-voltage battery.

It is essential that the contacts are reached with the gauge tips when measuring.

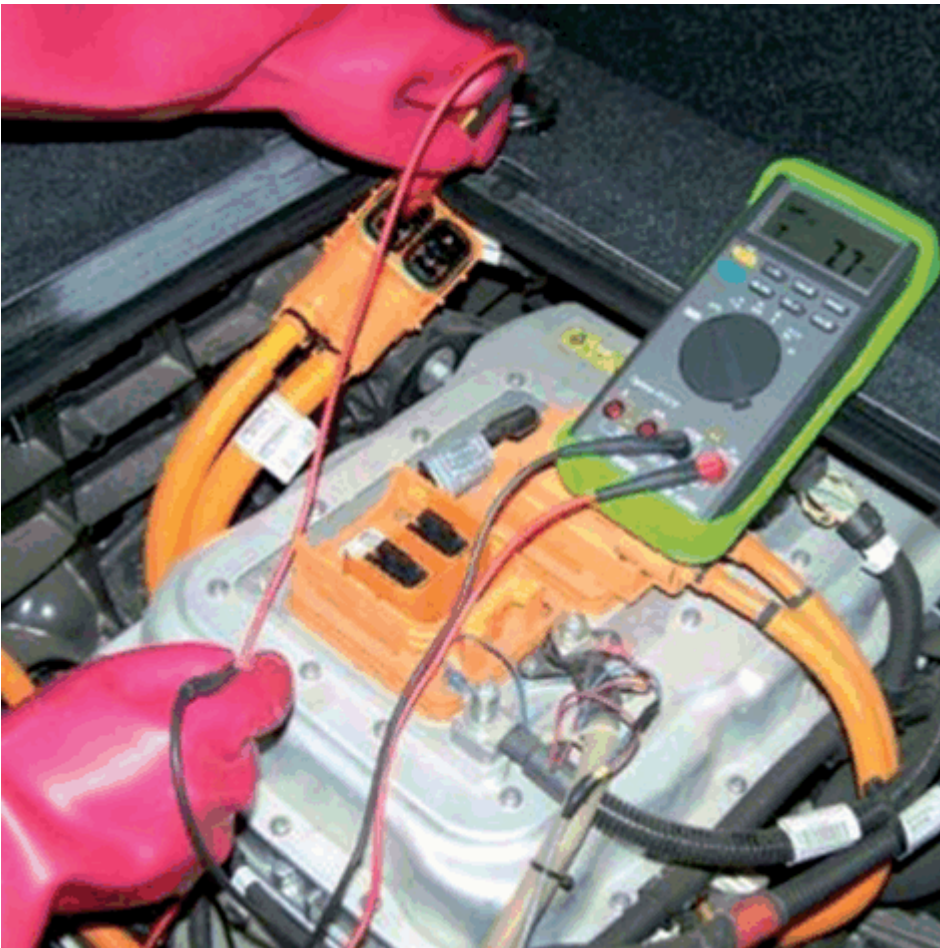

In the next step, measurements can be taken from each of the contacts to the housing of the electrical machine electronics. The housings of all high-voltage components are connected via GND by means of potential compensation lines (aluminium drive module). If a high-voltage potential is present at the housing and/or at GND due to damage, it can be measured with this procedure.

If it is not possible to measure the voltage in any of the tests, it can be assumed that there is no risk from the system.

9. Installing the high-voltage connector



In order to rule out further improper treatment, install and lock the high-voltage connector again. The smaller connector (HV switch-off) must **not** be installed again.

10. Close the engine compartment including service cap.

3.2 Vehicle fire

In general, all statutory requirements relating to a conventional vehicle on fire are to be observed.

No explosion will occur in the event of a reaction of the lithium ion high-voltage battery triggered by the fire. A quick thermal response will take place. Monitoring the high-voltage battery with a thermographic camera is therefore recommended.

Trapped persons can be rescued using suitable fire fighting equipment.

The BMW i01 consists of a carbon fibre passenger cell based on an aluminium drive module. The carbon fibre are not combustible. However, since these fibres are held together by a special resin, the resin may catch fire in the event of high temperatures.

Bear in mind that a fire may lead to the vehicle structure losing its original strength. After a fire, the vehicle solely consists of the structure of the drive module. Observe chapter 3.2.3 during recovery!

CAUTION

There is an electrical risk even after a vehicle has been on fire.

Danger of injury!

- Use personal protective equipment identical to that for conventional vehicle fires.
- Do not touch high-voltage components.

3.2.1 Extinguishing

In the event of fire, the high-voltage battery is to be cooled with a lot of water in order to prevent further reactions inside the high-voltage battery. When extinguishing the fire, audible processes can occur inside the high-voltage battery. This takes place in the safety valves of the battery cells. This process is no source of danger. These audible processes can also occur after extinguishing the fire.

CAUTION

BGI/GUV-I 8677 electrical risks at the scene of deployments.

Danger of injury!

- Observe the following safety distance when extinguishing:
- 1 m for spray jet
- 5 m for full jet

3.2.2 Determining the burnt-out vehicle has been de-energised

There may still be electrical hazard potential after the fire. The insulation of the high-voltage cables can be damaged or even removed by the heat.

In this case, the vehicle may only be approached when wearing personal protecting equipment.

As described in chapter 3.1.2, point 8, both cables need to be checked for the de-energised state in this case as well. In the next step, measurements need to be taken between both cables and the housing of the high-voltage battery. Further cables can be checked in the front part of the vehicle, if necessary. If a voltage potential is still present, the high-voltage cables coming out of the high-voltage battery need to be disconnected from the high-voltage battery. Therefore, the copper lines are to be insulated against each other and to be cut through **one by one** in order to prevent a short circuit. Afterwards, a short circuit to ground should be checked.

Note: The high-voltage cables of the high-voltage battery can be identified by their considerably greater cross-section. If the insulation is melted due to the fire, only the copper lines can be identified.

3.2.3 Procedure for fire residue in the vehicle

Personal protective equipment must be used when disposing of fire residues.

In case of fire, the high-voltage battery can bond to the roadway due to the high temperature. In this case, no metallic objects may be used to remove the high-voltage battery from the roadway. Since the carbon fibre structure no longer provides any strength, the vehicle needs to be lifted directly beneath the high-voltage battery. Lifting via the wheels does not help. The drive unit would be pulled out. The drive unit (front/rear axle) would disconnect from the life module.

The residues of the vehicle should be removed from the roadway using pointed wedges made of insulating material (for example wood). Afterwards, the high-voltage battery must be supported using insulating material in order to feed through the lifting sling. If a forklift truck is available, it can be used to lift the high-voltage battery (with insulating support between the high-voltage battery and the truck) and the vehicle.

The residues of the vehicle can be lifted onto a truck with insulation on the loading platform and then covered with an insulating cover. A corresponding high-voltage identification (warning sticker) must be attached.

First recovery of the vehicle with damaged high-voltage battery is secured by law.

3.3 Vehicles in and under water

Disconnect the high-voltage service disconnect and the 12 V battery (negative terminal) to switch off the high-voltage system after having recovered the vehicle from bodies of water. In case of airbag deployment, the switch-off of the high-voltage system can be assumed. Touching high-voltage components and high-voltage cables is to be avoided.

i TECHNICAL INFORMATION

After recovering the vehicle from water:

- Monitor the vehicle.
- Store the vehicle outdoors and keep at a sufficient distance from combustible materials.
- Provide unobstructed access for the fire brigade.

3.4 Split high-voltage batteries or high-voltage batteries that have been separated from the vehicle

The voltage within the high-voltage battery cannot in principle be switched off. The high-voltage battery of the BMW i01 is however designed to be intrinsically safe on the inside. This includes, for example, an adequate touching protection. All high-voltage cables can be plugged in and are highlighted in orange. In case of a damaged high-voltage battery, a damaged touching protection needs to be assumed.

In this very improbable case, electrical and thermal danger by the high-voltage battery need to be assumed. Adequate personal protective equipment is required.

The elements of the high-voltage battery should be lifted from the ground with insulating material (for example wood). If any elements are held together only by individual lines, disconnecting and/or cutting through the lines may be recommended. Disconnect and/or cut through lines one by one in order to provide dangerous short circuits.

The elements can be lifted onto a truck with insulating facing on the loading platform and then be covered with an insulating cover. Install an adequate high-voltage sign with a corresponding note.

First recovery of the vehicle with damaged high-voltage battery is secured by law.

4 Towing

When towing away a severely damaged vehicle, the following points need to be kept in mind:

- Observe notes on towing away inside the rescue manual, the emergency services data sheet and/or the Owner's Handbook.
- The vehicle may only be towed away by trained personnel.
- The high-voltage system is to be switched off before transporting (de-energised).
- Insulating tensioning straps and lifting gear are to be used.
- Not specifically trained persons are to be kept away.
- If the vehicle does not stand on its own wheels, adequate insulation material is to be used. The vehicle body may not have any metallic contact to the loading platform.
- The elements of the high-voltage battery can be lifted onto a truck with insulating facing on the loading platform and then be covered with an insulating cover.
- The vehicle is to be secured sufficiently in order to avoid further damage to the high-voltage battery due to movement.
- If the vehicle can be repaired, it should be transported to the nearest BMW authorised workshop if possible.

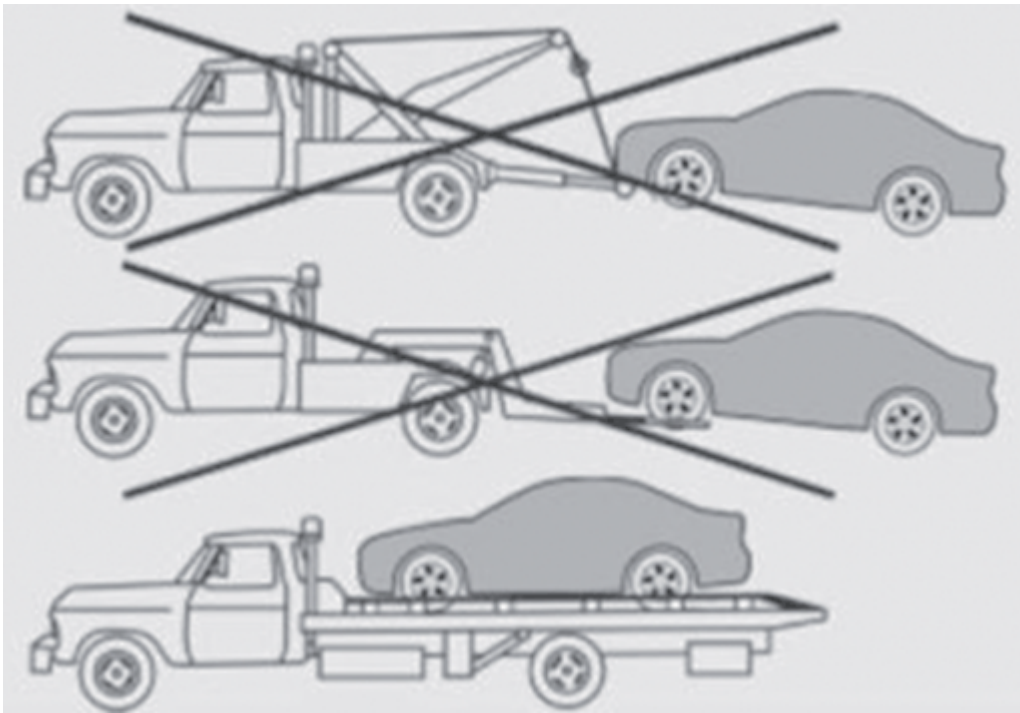

The vehicle must not be pulled or towed away. Transportation is possible exclusively on a truck. Any other variants of towing away a vehicle are forbidden. Pulling the vehicle out of the danger area is possible. Securing the vehicle via its wheels is recommended.

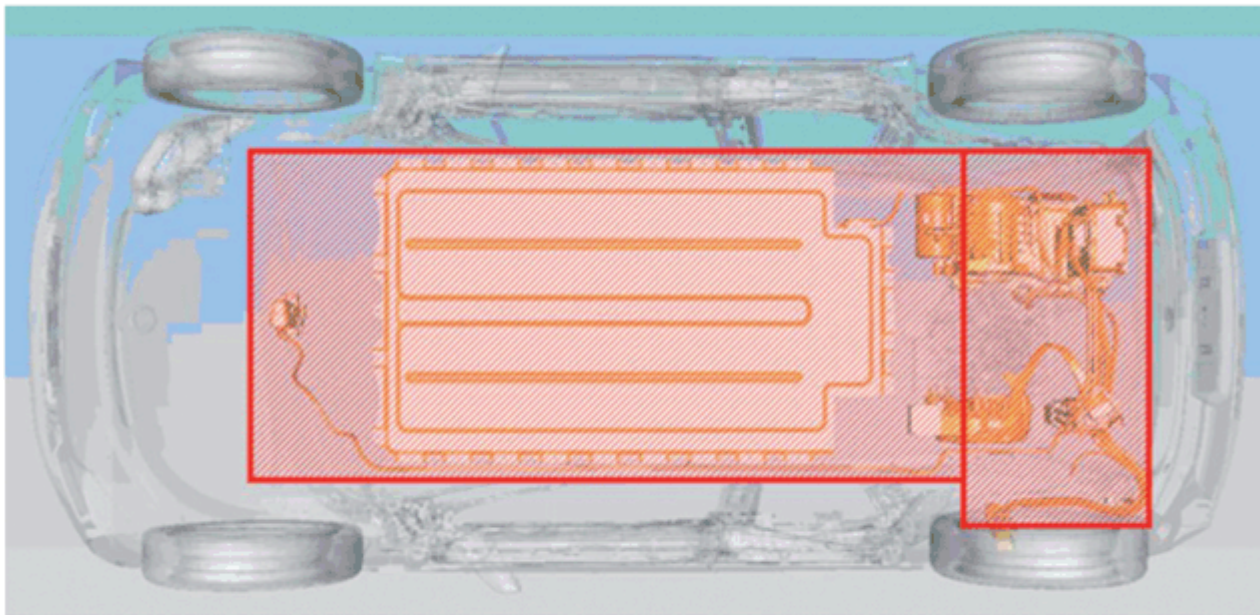

When lifting the vehicle, the areas surrounded by red colour may not be used as a supporting area (exception: after a fire)

I12 expert guide



1 Introduction

This guide is to be followed after a severe accident when the emergency service personnel is in doubt about the state of the high-voltage system.

Always observe country-specific guidelines.

In case the intrinsic safety of the vehicle is suspected not to be present any longer and a dangerous situation for the emergency service personnel is to be assumed, a qualified electrical specialist needs to be consulted.

In case of severe accidents with the risk of damage to the high-voltage battery being present, the high-voltage battery is automatically disconnected from the high-voltage system.

Prior to any further work on the vehicle (e.g. repair, recycling), an inspection must be carried out by suitably qualified personnel, according to the BMW specification.

The high-voltage system is generally to be considered intrinsically safe. In the event of an airbag deployment, there are two switch-off mechanisms in the vehicle that switch off the high-voltage system. Firstly, the system is switched off by blowing off the safety battery terminal from the 12V positive terminal of the battery. Secondly, by a CAN message which disconnects the voltage supply of the battery switch contactors in the high-voltage battery and switches off the system. The high-voltage system (IT system) consists of two separate circuits (HV+, HV-), which are completely decoupled from the 12 V vehicle electrical system. The electrical GND (-) has no high-voltage potential. Only the housings of the components are connected to GND to allow potential compensation. In order to provoke electrical damage, a person needs to be in-between the positive and the negative HV circuit. If no damaged high-voltage cables (orange-coloured lines) or high-voltage components are touched, an electric shock cannot occur under any circumstances.

Attention: The instructions described in the following are intended for use exclusively on the BMW i12.

2 Essential information

2.1 Definition of a severely damaged vehicle

A vehicle is to be considered severely damaged if at least one of the following preconditions are met:

- Intrusions or deformation of more than 5 millimetres at the housing of the high-voltage battery
- Vehicle is completely or partially under water (for example harbour basin, river, channel system)
- Vehicle completely or partially on fire

3 Rescue & Recovery

3.1 Securing the high-voltage system

Disconnect the plug connection of the high-voltage rescue isolation point and disconnect the 12 V battery (negative terminal) to switch off the high-voltage system (see emergency services data sheet for procedure).

In case of airbag deployment, the switch-off of the high-voltage system can be assumed. Touching high-voltage components and high-voltage cables is to be avoided. Ground straps (potential compensation) of the high-voltage components may not be cut through. The de-energised state can be read off from the instrument cluster (12 V battery must still be connected).

3.1.1 Deactivating the high-voltage system (de-energising)

The high-voltage rescue separation point and the 12 V battery are located underneath the engine compartment lid.

Disconnect the plug connection of the high-voltage rescue isolation point and disconnect the 12 V battery (negative terminal) to deactivate the high-voltage system (see emergency services data sheet).



High-voltage emergency separation point closed.



High-voltage emergency separation point open.

3.1.2 De-energising the system

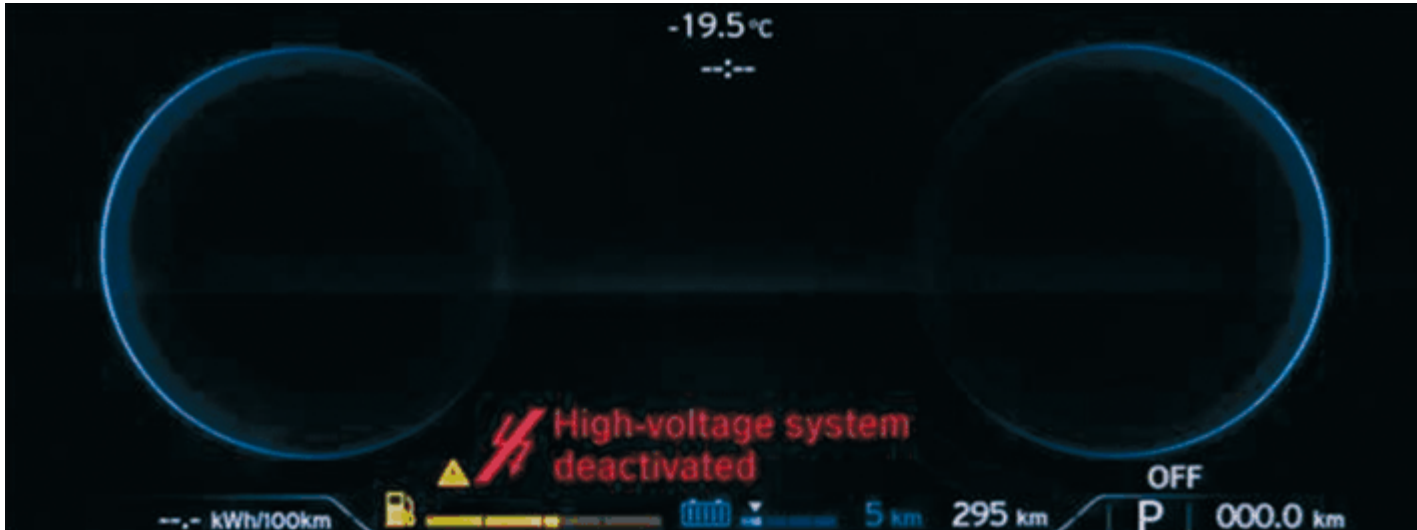

A switched off high-voltage system can be identified via the Check Control message "High-voltage system deactivated" in the instrument cluster.

Note: Connect the 12 V battery and carry out a terminal change (switch the vehicle off and on again using the start/stop button) to display the information.

3.2 Vehicle fire

In general, all statutory requirements relating to a conventional vehicle on fire are to be observed.

No explosion will occur in the event of a reaction of the lithium ion high-voltage battery triggered by the fire. A quick thermal response will take place. Monitoring the high-voltage battery with a thermographic camera is therefore recommended.

Trapped persons can be rescued using suitable fire fighting equipment.

The BMW I12 consists of a carbon fibre passenger cell. The carbon fibre are not combustible. However, since these fibres are held together by a special resin, the resin may catch fire in the event of high temperatures.

Bear in mind that a fire may lead to the vehicle structure losing its original strength. After a fire, the vehicle solely consists of the structure of the drive module. Observe chapter 3.2.3 during recovery!

CAUTION

There is an electrical risk even after a vehicle has been on fire.

Danger of injury!

- Use personal protective equipment identical to that for conventional vehicle fires.
- Do not touch high-voltage components.

3.2.1 Extinguishing

In the event of fire, the high-voltage battery is to be cooled with a lot of water in order to prevent further reactions inside the high-voltage battery. When extinguishing the fire, audible processes can occur inside the high-voltage battery. This takes place in the safety valves of the battery cells. This process is no source of danger. These audible processes can also occur after extinguishing the fire.

CAUTION

BGI/GUV-I 8677 electrical risks at the scene of deployments.

Danger of injury!

- Observe the following safety distance when extinguishing:
- 1 m for spray jet
- 5 m for full jet

3.2.2 Determining the burnt-out vehicle has been de-energised

There may still be electrical hazard potential after the fire. The insulation of the high-voltage cables can be damaged or even removed by the heat.

In this case, the vehicle may only be approached when wearing personal protecting equipment.

After the fire has been extinguished, any high-voltage cables must be disconnected from the high-voltage battery, if they are accessible. Therefore, the copper lines are to insulated against each other and to be cut through one by one in order to prevent a short circuit. Afterwards, a short circuit to ground should be checked.

Note: The high-voltage cables of the high-voltage battery can be identified by their considerably greater cross-section. If the insulation has melted due to the fire, only the copper wires can be identified.

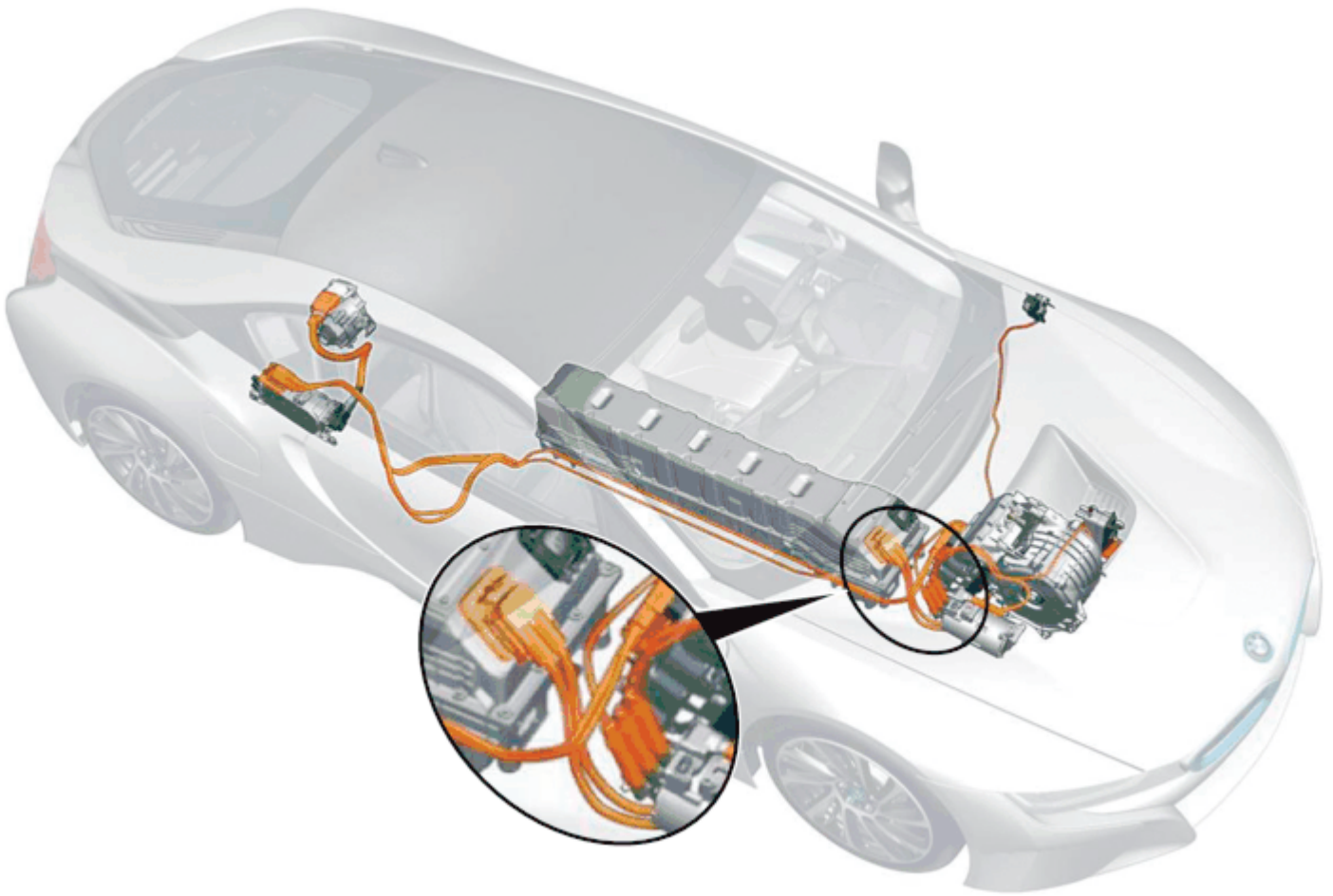

Position of the high-voltage components

3.2.3 Procedure for fire residue in the vehicle

Personal protective equipment must be used when disposing of fire residues.

In case of fire, the high-voltage battery can bond to the roadway due to the high temperature. In this case, no metallic objects may be used to remove the high-voltage battery from the roadway. Since the carbon fibre structure no longer provides any strength, the vehicle needs to be lifted directly beneath the high-voltage battery. Lifting via the wheels does not help. The drive unit (front/rear axle) would disconnect from the life module.

The residues of the vehicle should be removed from the roadway using pointed wedges made of insulating material (for example wood). Afterwards, the high-voltage battery must be supported using insulating material in order to feed through the lifting sling. If a forklift truck is available, it can be used to lift the high-voltage battery (with insulating support between the high-voltage battery and the truck) and the vehicle.

The residues of the vehicle can be lifted onto a truck with insulation on the loading platform and then covered with an insulating cover. A corresponding high-voltage identification (warning sticker) must be attached.

First recovery of the vehicle with damaged high-voltage battery is secured by law.

3.3 Vehicles in and under water

Disconnect the high-voltage service disconnect and the 12 V battery (negative terminal) to switch off the high-voltage system after having recovered the vehicle from bodies of water. In case of airbag deployment, the switch-off of the high-voltage system can be assumed. Touching high-voltage components and high-voltage cables is to be avoided.

i TECHNICAL INFORMATION

After recovering the vehicle from water:

- Monitor the vehicle.
- Store the vehicle outdoors and keep at a sufficient distance from combustible materials.
- Provide unobstructed access for the fire brigade.

3.4 Split high-voltage batteries or high-voltage batteries that have been separated from the vehicle

The voltage within the high-voltage battery cannot in principle be switched off. The high-voltage battery of the BMW I12 is however designed to be intrinsically safe on the inside. This includes, for example, an adequate touching protection. All high-voltage cables can be plugged in and are highlighted in orange. In case of a damaged high-voltage battery, a damaged touching protection needs to be assumed.

In this very improbable case, electrical and thermal danger by the high-voltage battery need to be assumed. Adequate personal protective equipment is required.

The elements of the high-voltage battery should be lifted from the ground with insulating material (for example wood). If any elements are held together only by individual lines, disconnecting and/or cutting through the lines may be recommended. Disconnect and/or cut through lines one by one in order to provide dangerous short circuits.

The elements can be lifted onto a truck with insulating facing on the loading platform and then be covered with an insulating cover. Install an adequate high-voltage sign with a corresponding note.

First recovery of the vehicle with damaged high-voltage battery is secured by law.

4 Towing

When towing away a severely damaged vehicle, the following points need to be kept in mind:

- Observe notes on towing away inside the rescue manual, the emergency services data sheet and/or the Owner's Handbook.
- The vehicle may only be towed away by trained personnel.
- The high-voltage system is to be switched off before transporting (de-energised).
- Insulating tensioning straps and lifting gear are to be used.
- Not specifically trained persons are to be kept away.
- If the vehicle does not stand on its own wheels, adequate insulation material is to be used. The vehicle body may not have any metallic contact to the loading platform.
- The elements of the high-voltage battery can be lifted onto a truck with insulating facing on the loading platform and then be covered with an insulating cover.
- The vehicle is to be secured sufficiently in order to avoid further damage to the high-voltage battery due to movement.
- If the vehicle can be repaired, it should be transported to the nearest BMW authorised workshop if possible.

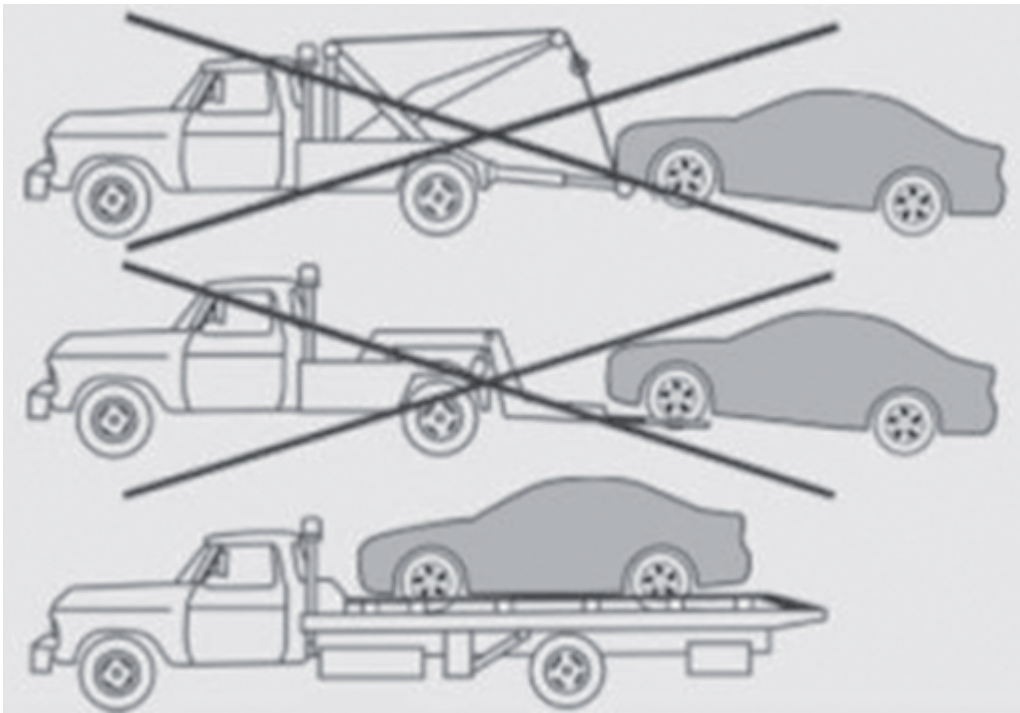

The vehicle must not be pulled or towed away. Transportation is possible exclusively on a truck. Any other variants of towing away a vehicle are forbidden. Pulling the vehicle out of the danger area is possible. Securing the vehicle via its wheels is recommended.

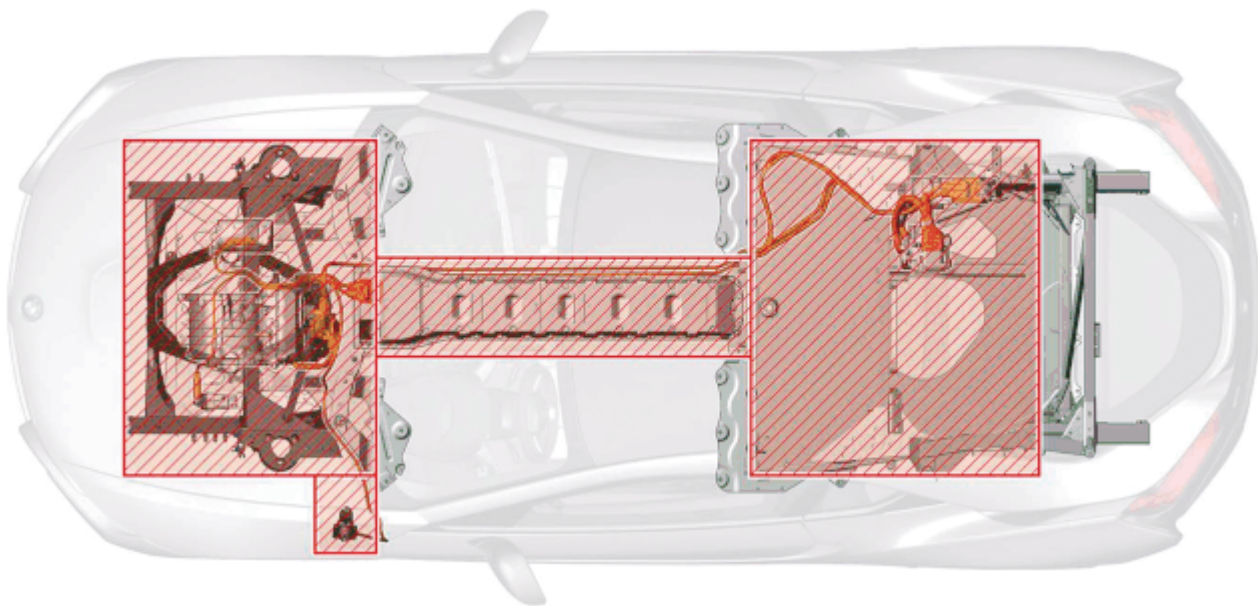

When lifting the vehicle, the areas surrounded by red colour may not be used as a supporting area (exception: after a fire)

BMW 530Le F18 PHEV expert guide



1 Introduction

This guide is to be followed after a severe accident when the emergency service personnel is in doubt about the state of the high-voltage system.

Always observe country-specific guidelines.

In case the intrinsic safety of the vehicle is suspected not to be present any longer and a dangerous situation for the emergency service personnel is to be assumed, a qualified electrical specialist needs to be consulted.

In case of severe accidents with the risk of damage to the high-voltage battery being present, the high-voltage battery is automatically disconnected from the high-voltage system.

Prior to any further work on the vehicle (e.g. repair, recycling), an inspection must be carried out by suitably qualified personnel, according to the BMW specification.

The high-voltage system is generally to be considered intrinsically safe. In the event of an airbag deployment, there are two switch-off mechanisms in the vehicle that switch off the high-voltage system. Firstly, the system is switched off by blowing off the safety battery terminal from the 12V positive terminal of the battery. Secondly, by a CAN message which disconnects the voltage supply of the battery switch contactors in the high-voltage battery and switches off the system. The high-voltage system (IT system) consists of two separate circuits (HV+, HV-), which are completely decoupled from the 12 V vehicle electrical system. The electrical GND (-) has no high-voltage potential. Only the housings of the components are connected to GND to allow potential compensation. In order to provoke electrical damage, a person needs to be in-between the positive and the negative HV circuit. If no damaged high-voltage cables (orange-coloured lines) or high-voltage components are touched, an electric shock cannot occur under any circumstances.

Attention: The instructions described in the following are intended for use with the BMW F18 PHEV only.

2 Essential information

2.1 Vehicle type

The BMW 530Le is a PHEV. The abbreviation PHEV stands for "Plug-in Hybrid Electric Vehicle" – a motor vehicle with hybrid drive, the high-voltage battery of which can also be charged externally via the power grid.

2.2 Definition of a severely damaged vehicle

A vehicle is to be considered severely damaged if at least one of the following preconditions are met:

- Intrusions or deformation of more than 5 millimetres at the housing of the high-voltage battery
- Vehicle is completely or partially under water (for example harbour basin, river, channel system)
- Vehicle completely or partially on fire

3 Rescue & Recovery

3.1 Securing the high-voltage system

Disconnect the plug connection of the high-voltage rescue isolation point and disconnect the 12 V battery (negative terminal) to switch off the high-voltage system (see emergency services data sheet for procedure).

In case of airbag deployment, the switch-off of the high-voltage system can be assumed. Touching high-voltage components and high-voltage cables is to be avoided. Ground straps (potential compensation) of the high-voltage components may not be cut through. The de-energised state can be read off from the instrument cluster (12 V batteries must still be connected) or determined by a qualified electrician using defined measurements.

3.1.1 Deactivating the high-voltage system (de-energising)

The high-voltage service disconnect (installation location: on the right behind the luggage compartment trim panel) and both 12 V batteries (system battery and auxiliary battery).

The high-voltage system is deactivated by:

- Unlocking the plug connection (pull apart high-voltage service disconnect in direction of arrow) of the high-voltage rescue separation point (see graphic) as well as

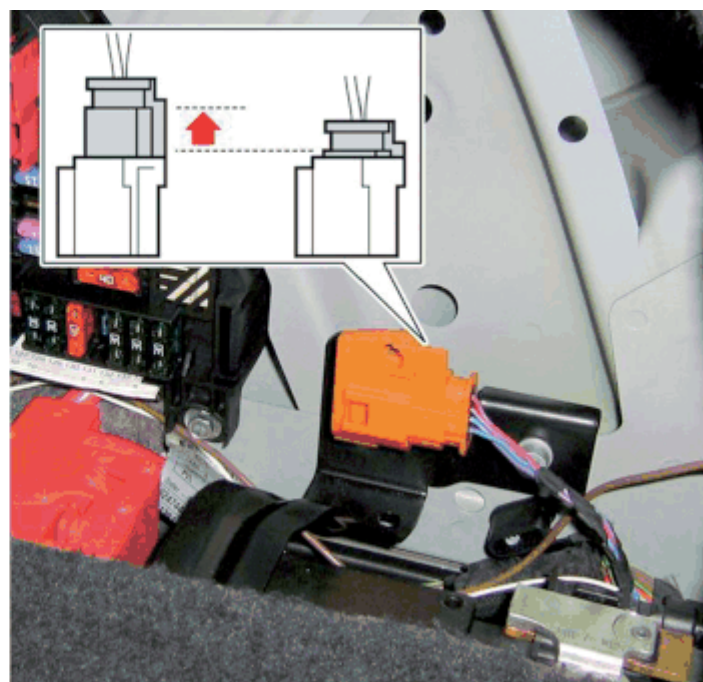

- Disconnecting the 12 V batteries at the negative terminal (see emergency services card)

If the high-voltage rescue separation point in the luggage compartment cannot be accessed, the high-voltage system can be switched off at the large high-voltage connector of the high-voltage battery behind the rear seat bench.

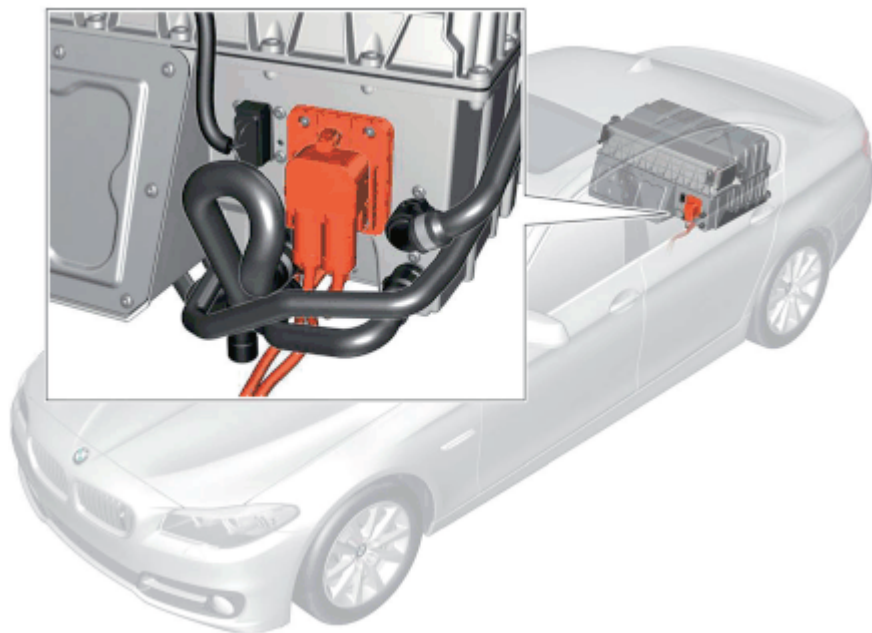

Installation position of high-voltage battery behind the rear seat bench

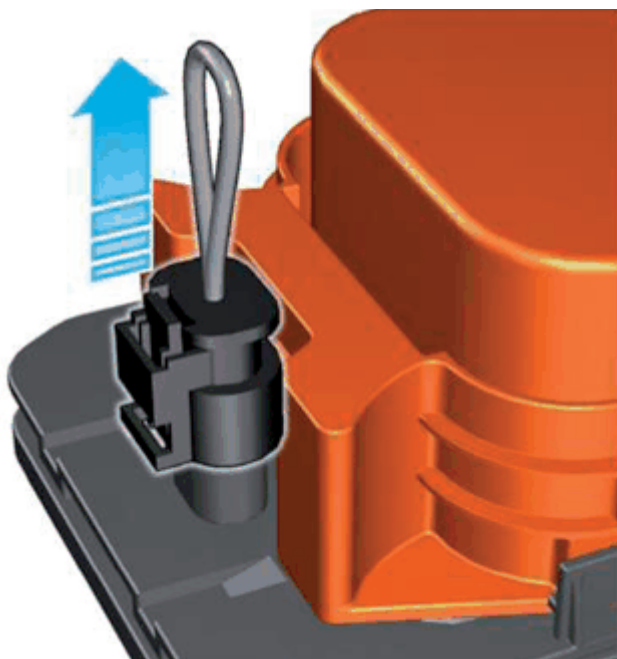

The high-voltage system is to be switched off by removing the small pole connector (HV interlock) (see chapter 3.1.2 point 8).

3.1.2 De-energising the system

A switched off high-voltage system can be identified via the Check Control message "High-voltage system deactivated" in the instrument cluster.

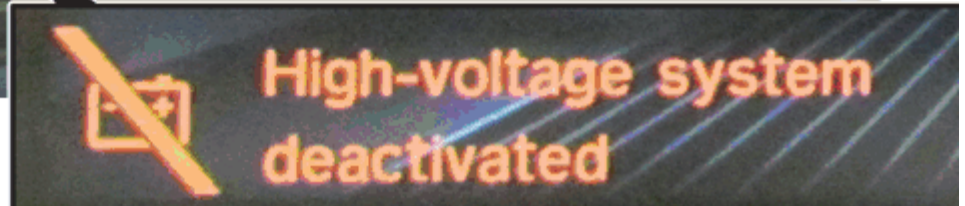

Note: Connect the 12 V battery and carry out a terminal change (switch the vehicle off and on again using the start/stop button) to display the information.

If the de-energised state cannot be identified by means of the instrument cluster, the state can be identified by a qualified electrical specialists with personal protective equipment via the following measurements.

Operations:

1. Switch off vehicle. Put vehicle in passive state via START-STOP button.
2. Remove the ignition key from the vehicle.
3. Open tailgate.
4. Disconnect the 12 V batteries.



Installation positions of the 12 V batteries

- On the right behind the luggage compartment trim panel (auxiliary battery)
- In the centre under the storage shelf (system battery)

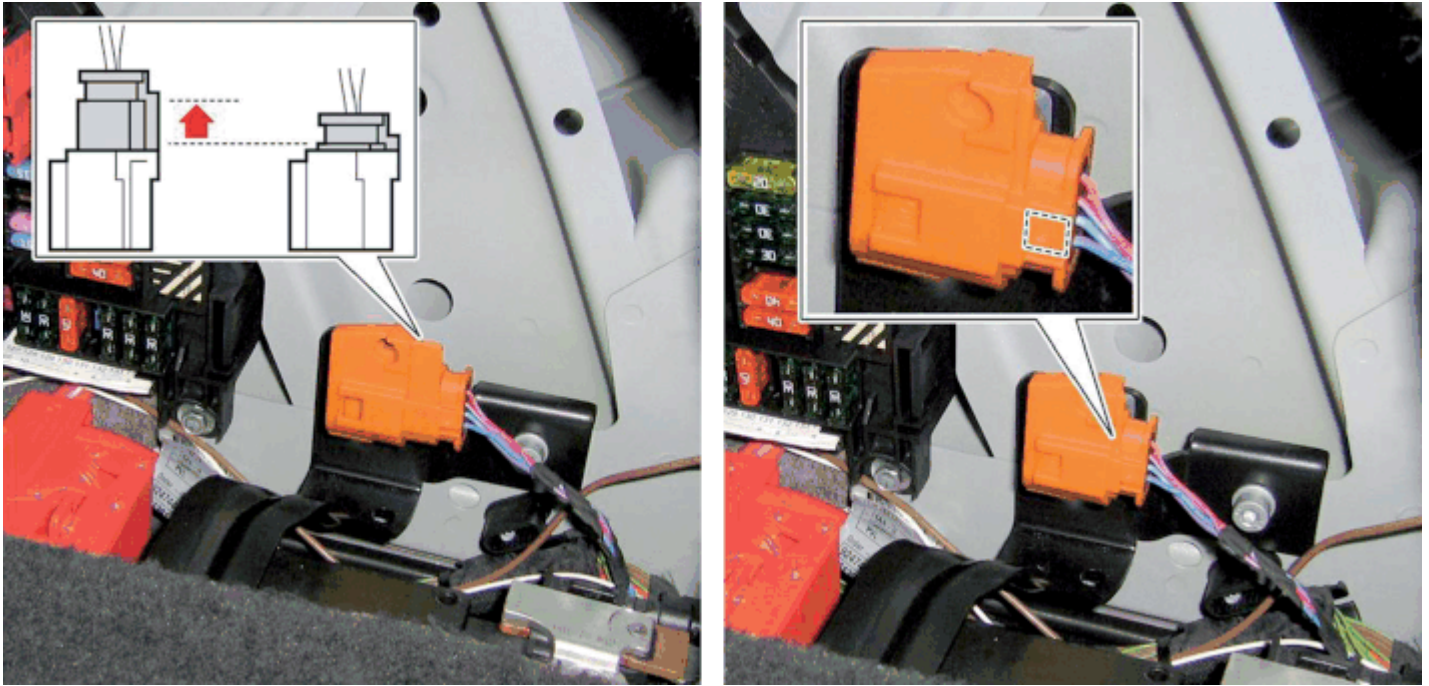

5. Pull apart the small connector (high-voltage service disconnect) at the high-voltage rescue separation point.



6. Disassemble the rear seat bench by the reaching underneath and pulling firmly.



7. Disassembly of the rear seat backrest by loosening the screw connection (Torx T50).



Detach the rear seat backrest by lifting.

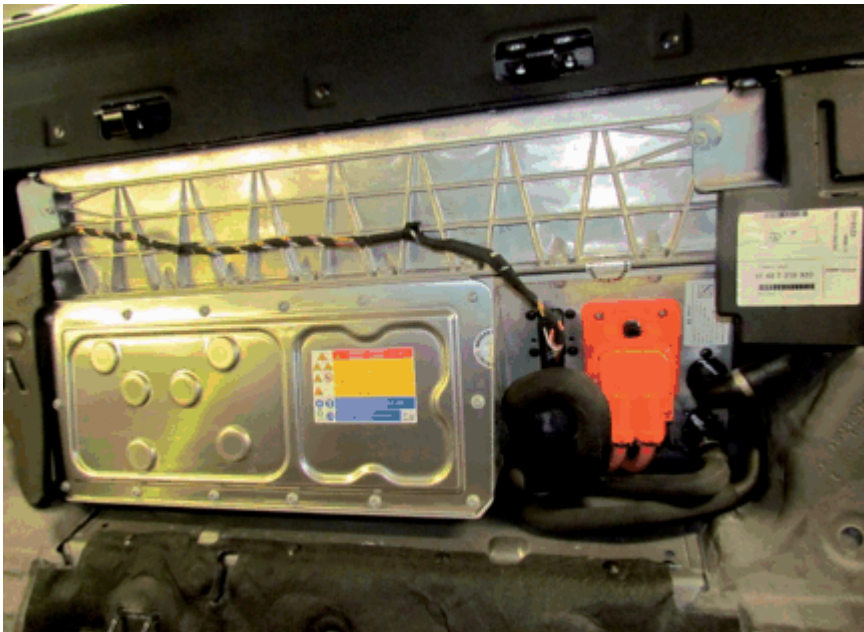

The high-voltage battery is located behind the rear seat backrest.

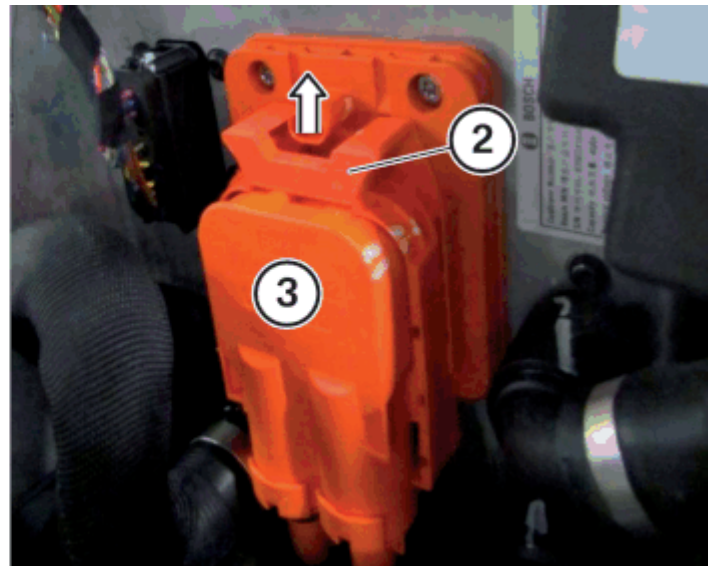
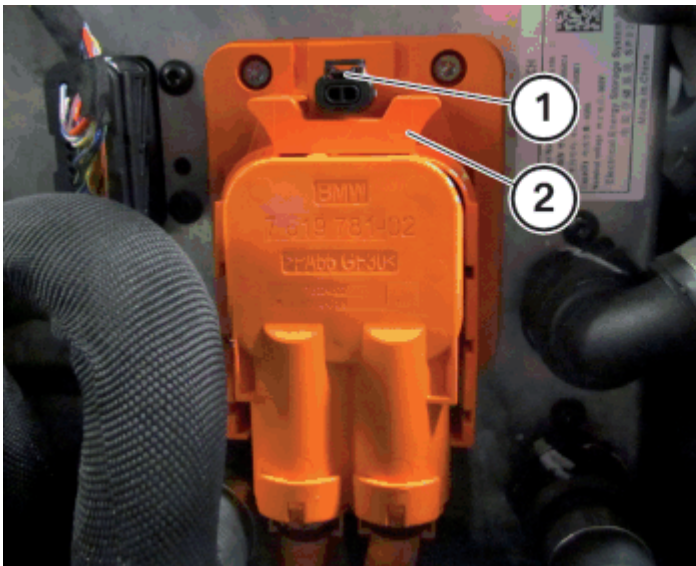

8. Disconnect high-voltage connector.

- Remove "HV interlock" (1)
- Pull out lock (2) in direction of arrow up to limit position
- Pull off high-voltage connector (3)

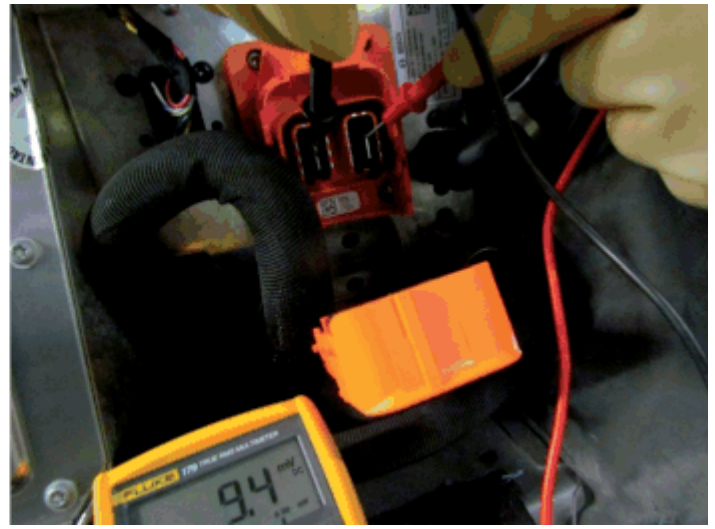
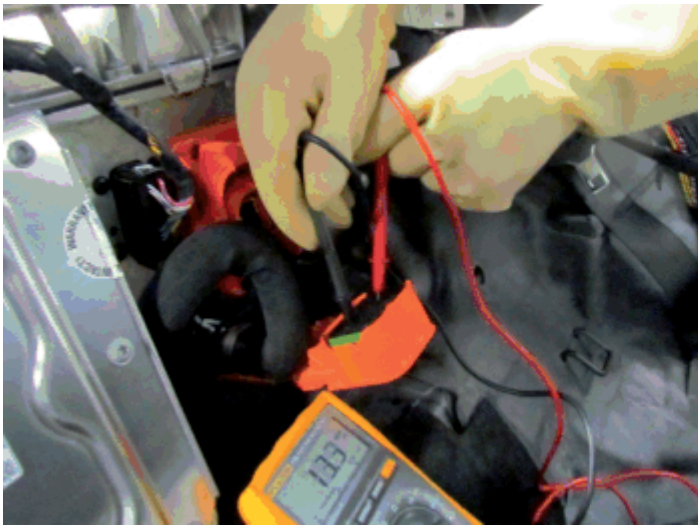

9. Measure the de-energised state at the high-voltage connector

The disconnected high-voltage cable is directly linked to high-voltage battery.

It is essential that the contacts are reached with the gauge tips when measuring.

In the next step, measurements can be taken from each of the contacts to the housing of the high-voltage battery. The housings of all high-voltage components are connected via GND by means of potential compensation lines. If a high-voltage potential is present at the housing and/or at GND due to damage, it can be measured with this procedure.

If it is not possible to measure the voltage in any of the tests, it can be assumed that there is no risk from the system.

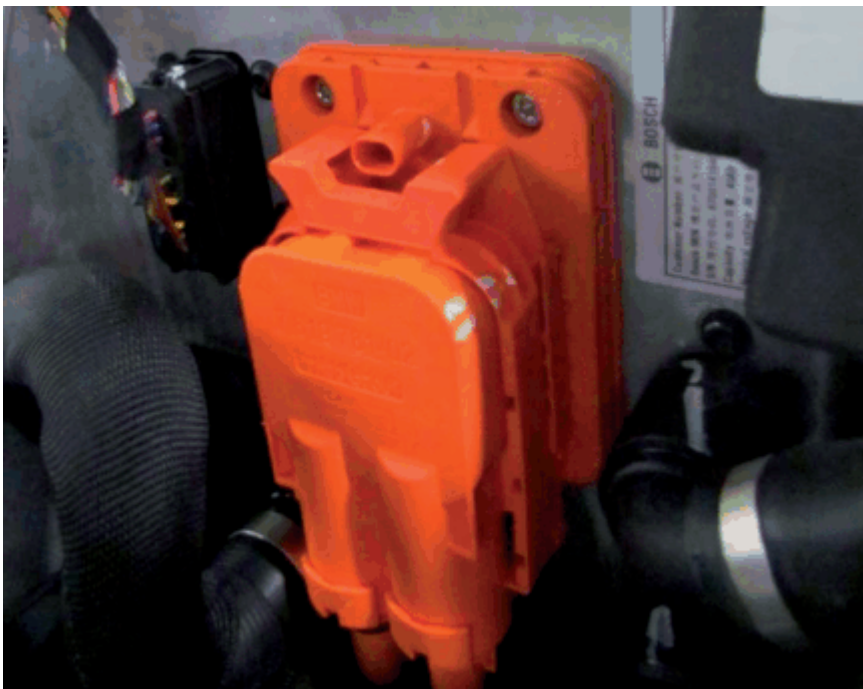

10. Installing the high-voltage connector

In order to rule out further improper treatment, install and lock the high-voltage connector again. The smaller connector (HV interlock) must not be installed again.

3.2 Vehicle fire

In general, all statutory requirements relating to a conventional vehicle on fire are to be observed.

No explosion will occur in the event of a reaction of the lithium ion high-voltage battery triggered by the fire. A quick thermal response will take place. Monitoring the high-voltage battery with a thermographic camera is therefore recommended.

Trapped persons can be rescued using suitable fire fighting equipment.

As with conventional vehicles, hazardous smoke may be produced if the vehicle catches fire (e.g. due to burning plastics).

CAUTION

There is an electrical risk even after a vehicle has been on fire.

Danger of injury!

- Use personal protective equipment identical to that for conventional vehicle fires.
- Do not touch high-voltage components.

3.2.1 Extinguishing

In the event of fire, the high-voltage battery is to be cooled with a lot of water in order to prevent further reactions inside the high-voltage battery. When extinguishing the fire, audible processes can occur inside the high-voltage battery. This takes place in the safety valves of the battery cells. This process is no source of danger. These audible processes can also occur after extinguishing the fire.

CAUTION

BGI/GUV-I 8677 electrical risks at the scene of deployments.

Danger of injury!

- Observe the following safety distance when extinguishing:
 - 1 m for spray jet
 - 5 m for full jet

3.2.2 Determining the burnt-out vehicle has been de-energised

There may still be electrical hazard potential after the fire. The insulation of the high-voltage cables can be damaged or even removed by the heat.

In this case, the vehicle may only be approached when wearing personal protecting equipment.

As described in chapter 3.1.2, point 9, both cables need to be checked for the de-energised state in this case as well. In the next step, measurements need to be taken between both cables and the housing of the high-voltage battery. Further cables can be checked in the front part of the vehicle, if necessary. If a voltage potential is still present, the high-voltage cables coming out of the high-voltage battery need to be disconnected from the high-voltage battery. Therefore, the copper lines are to be insulated against each other and to be cut through **one by one** in order to prevent a short circuit. Afterwards, a short circuit to ground should be checked.

Note: The high-voltage cables of the high-voltage battery can be identified by their considerably greater cross-section. If the insulation is melted due to the fire, only the copper lines can be identified.

3.3 Vehicles in and under water

Disconnect the high-voltage service disconnect and the 12 V battery (negative terminal) to switch off the high-voltage system after having recovered the vehicle from bodies of water. In case of airbag deployment, the switch-off of the high-voltage system can be assumed. Touching high-voltage components and high-voltage cables is to be avoided.

i TECHNICAL INFORMATION

After recovering the vehicle from water:

- Monitor the vehicle.
- Store the vehicle outdoors and keep at a sufficient distance from combustible materials.
- Provide unobstructed access for the fire brigade.

3.4 Split high-voltage batteries or high-voltage batteries that have been separated from the vehicle

The voltage within the high-voltage battery cannot in principle be switched off. The high-voltage battery is, however, designed to be intrinsically safe on the inside. This includes, for example, an adequate touching protection. All high-voltage cables can be plugged in and are highlighted in orange. In case of a damaged high-voltage battery, a damaged touching protection needs to be assumed.

In this very improbable case, electrical and thermal danger by the high-voltage battery need to be assumed. Adequate personal protective equipment is required.

The elements of the high-voltage battery should be lifted from the ground with insulating material (for example wood). If any elements are held together only by individual lines, disconnecting and/or cutting through the lines may be recommended. Disconnect and/or cut through lines one by one in order to provide dangerous short circuits.

The elements can be lifted onto a truck with insulating facing on the loading platform and then be covered with an insulating cover. Install an adequate high-voltage sign with a corresponding note.

First recovery of the vehicle with damaged high-voltage battery is secured by law.

4 Towing

When towing away a severely damaged vehicle, the following points need to be kept in mind:

- Observe notes on towing away inside the rescue manual, the emergency services data sheet and/or the Owner's Handbook.
- The vehicle may only be towed away by trained personnel.
- The high-voltage system is to be switched off before transporting (de-energised).
- Insulating tensioning straps and lifting gear are to be used.
- Not specifically trained persons are to be kept away.
- If the vehicle does not stand on its own wheels, adequate insulation material is to be used. The vehicle body may not have any metallic contact to the loading platform.
- The elements of the high-voltage battery can be lifted onto a truck with insulating facing on the loading platform and then be covered with an insulating cover.
-

The vehicle is to be secured sufficiently in order to avoid further damage to the high-voltage battery due to movement.

- If the vehicle can be repaired, it should be transported to the nearest BMW authorised workshop if possible.

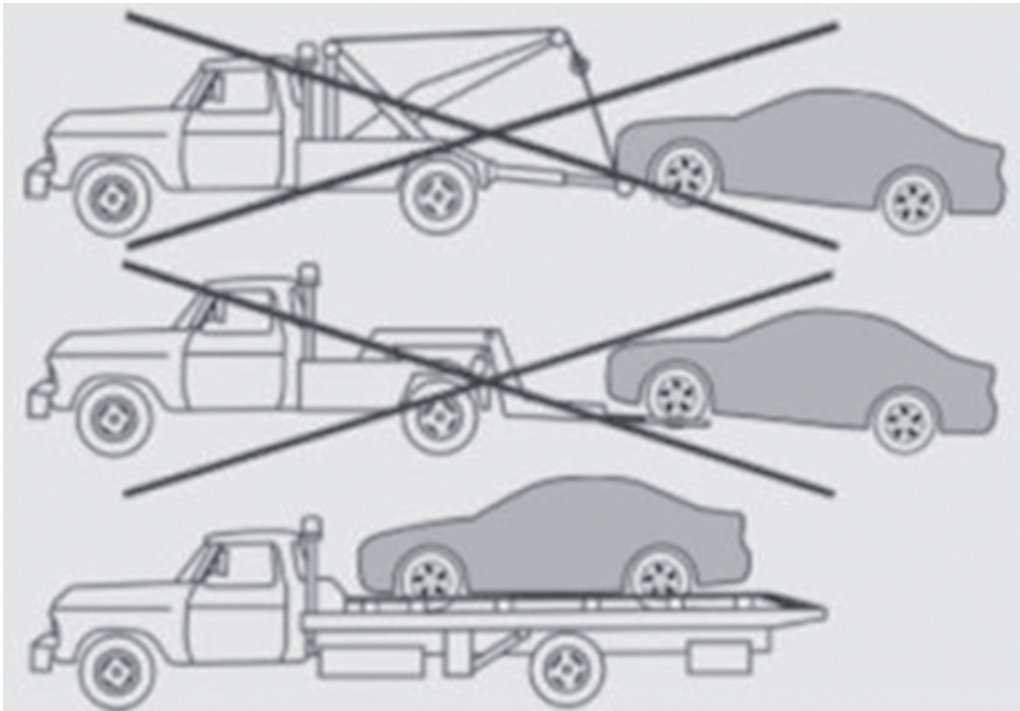

The vehicle must not be pulled or towed. Transportation is possible exclusively on a truck. Any other variants of towing away a vehicle are forbidden. Pulling the vehicle out of the danger area is possible. Securing the vehicle via its wheels is recommended.

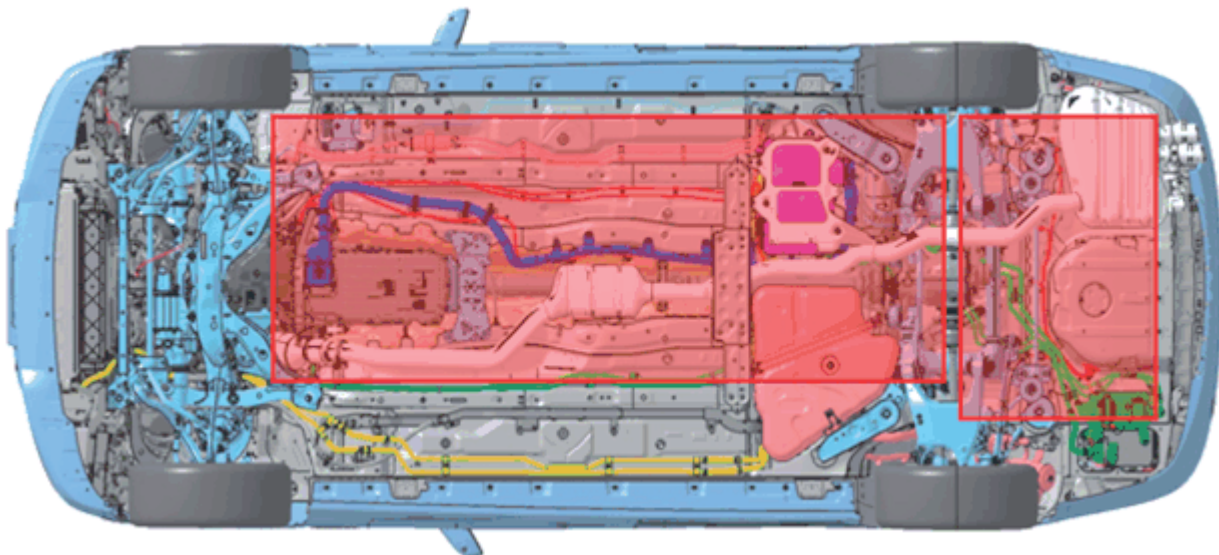

When lifting the vehicle, the areas surrounded by red colour may not be used as a supporting area (exception: after a fire)

X5 F15 PHEV expert guide



1 Introduction

This guide is to be followed after a severe accident when the emergency service personnel is in doubt about the state of the high-voltage system.

Always observe country-specific guidelines.

In case the intrinsic safety of the vehicle is suspected not to be present any longer and a dangerous situation for the emergency service personnel is to be assumed, a qualified electrical specialist needs to be consulted.

In case of severe accidents with the risk of damage to the high-voltage battery being present, the high-voltage battery is automatically disconnected from the high-voltage system.

Prior to any further work on the vehicle (e.g. repair, recycling), an inspection must be carried out by suitably qualified personnel, according to the BMW specification.

The high-voltage system is generally to be considered intrinsically safe. In the event of an airbag deployment, there are two switch-off mechanisms in the vehicle that switch off the high-voltage system. Firstly, the system is switched off by blowing off the safety battery terminal from the 12V positive terminal of the battery. Secondly, by a CAN message which disconnects the voltage supply of the battery switch contactors in the high-voltage battery and switches off the system. The high-voltage system (IT system) consists of two separate circuits (HV+, HV-), which are completely decoupled from the 12 V vehicle electrical system. The electrical GND (-) has no high-voltage potential. Only the housings of the components are connected to GND to allow potential compensation. In order to provoke electrical damage, a person needs to be in-between the positive and the negative HV circuit. If no damaged high-voltage cables (orange-coloured lines) or high-voltage components are touched, an electric shock cannot occur under any circumstances.

Attention: The instructions described in the following are intended for use with the BMW X5 F15 PHEV only.

2 Essential information

2.1 Vehicle type

The BMW X5 F15 eDrive is a so-called Plug-in Hybrid Electric Vehicle. The abbreviation PHEV stands for "Plug-in Hybrid Electric Vehicle" – a motor vehicle with hybrid drive, the high-voltage battery of which can also be charged externally via the power grid.

2.2 Definition of a severely damaged vehicle

A vehicle is to be considered severely damaged if at least one of the following preconditions are met:

- Intrusions or deformation of more than 5 millimetres at the housing of the high-voltage battery
- Vehicle is completely or partially under water (for example harbour basin, river, channel system)
- Vehicle completely or partially on fire

3 Rescue & Recovery

3.1 Securing the high-voltage system

Disconnect the plug connection of the high-voltage rescue isolation point and disconnect the 12 V battery (negative terminal) to switch off the high-voltage system (see emergency services data sheet for procedure).

In case of airbag deployment, the switch-off of the high-voltage system can be assumed. Touching high-voltage components and high-voltage cables is to be avoided. Ground straps (potential compensation) of the high-voltage components may not be cut through. The de-energised state can be read off from the instrument cluster (12 V batteries must still be connected) or determined by a qualified electrician using defined measurements.

3.1.1 Deactivating the high-voltage system (de-energising)

The luggage compartment features the high-voltage rescue isolation point (EBO: on the right behind the luggage compartment trim panel) and both 12 V batteries (system battery and auxiliary battery).

The high-voltage system is deactivated by:

- Remove the red connector lock (1) and pull apart the plug connection of the high-voltage rescue isolation point (2) (high-voltage service disconnect)

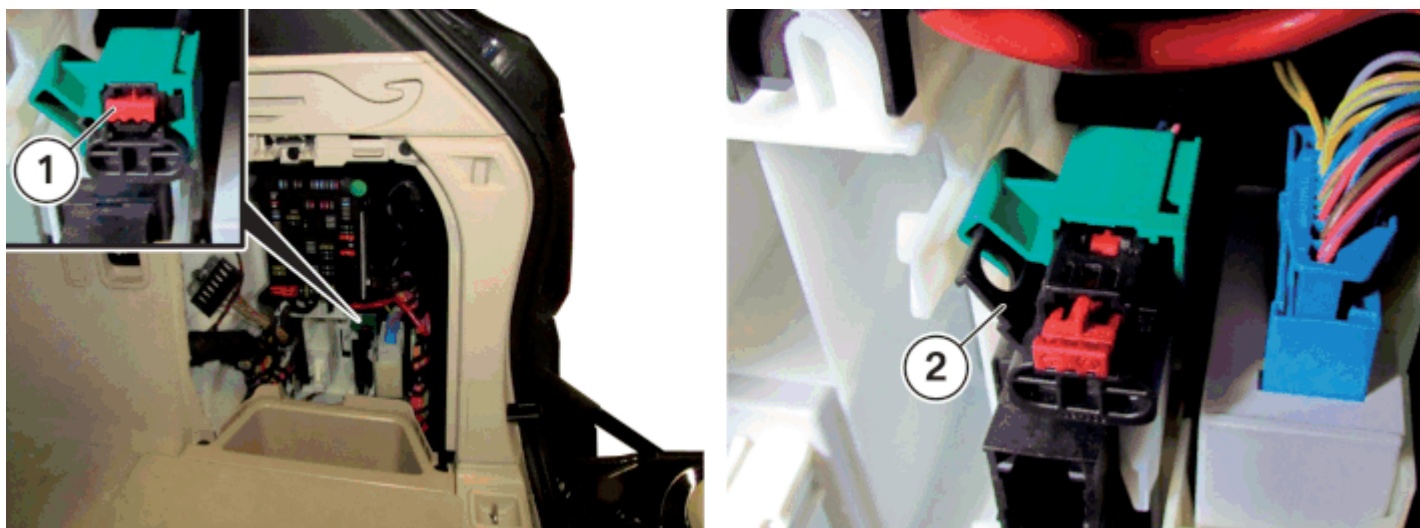

- Disconnect the 12 V batteries at the negative terminal (see emergency services data sheet)

If the high-voltage rescue separation point behind the trim panel cannot be accessed, the high-voltage system is switched off at the large high-voltage connector of the high-voltage battery (installation position below the luggage compartment floor cover).

The high-voltage system is to be switched off by removing the small pole connector (HV interlock) (see chapter 3.1.2 point 8).

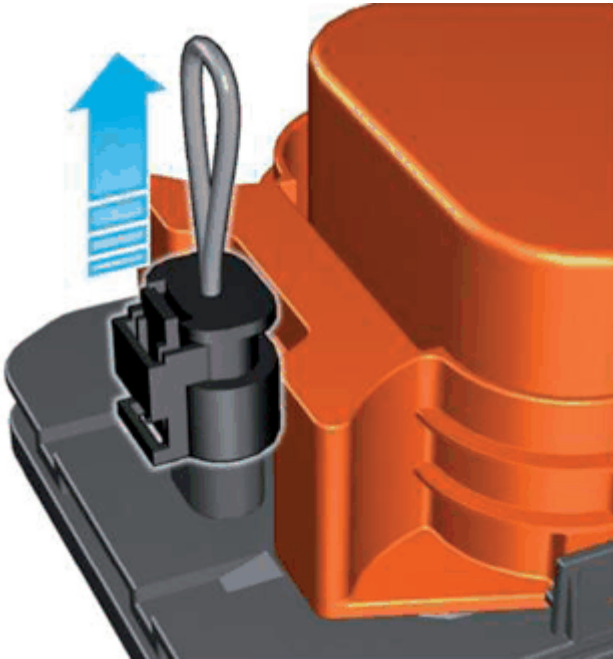

3.1.2 De-energising the system

A switched off high-voltage system can be identified via the message "High-voltage system deactivated" in the instrument cluster.



Note: Connect the 12 V battery and carry out a terminal change (switch the vehicle off and on again using the start/stop button) to display the information.

If the de-energised state cannot be identified by means of the instrument cluster, the state can be identified by a qualified electrical specialists with personal protective equipment via the following measurements.

Operations:

1. Switch off vehicle. Put vehicle in passive state via START-STOP button.
2. Remove vehicle key



3. Open tailgate and lift luggage compartment floor cover (1).



After lifting the luggage compartment floor cover:

- Loosen the expanding rivets (1) and screws (2), remove the storage tray (3).
- Open right side trim panel (4).

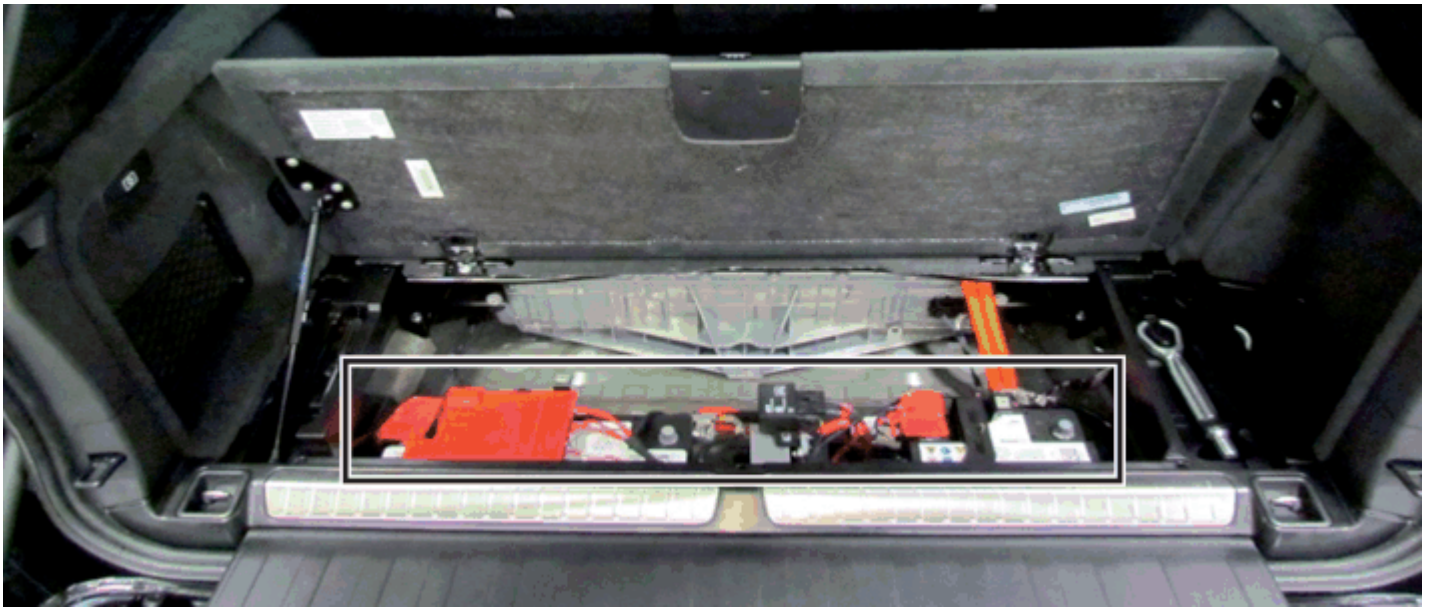

4. Disconnect the 12 V batteries at the negative terminal.

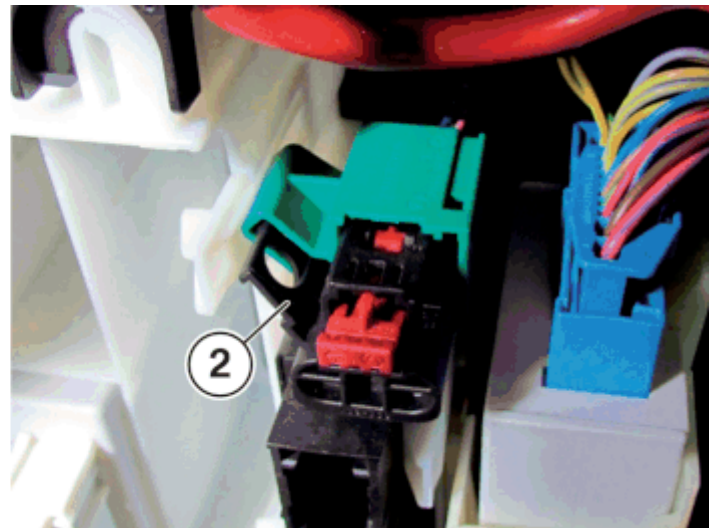

5. Disconnect the red connector lock (1). Pull apart the plug connection of the high-voltage rescue isolation point (2) (high-voltage service disconnect).

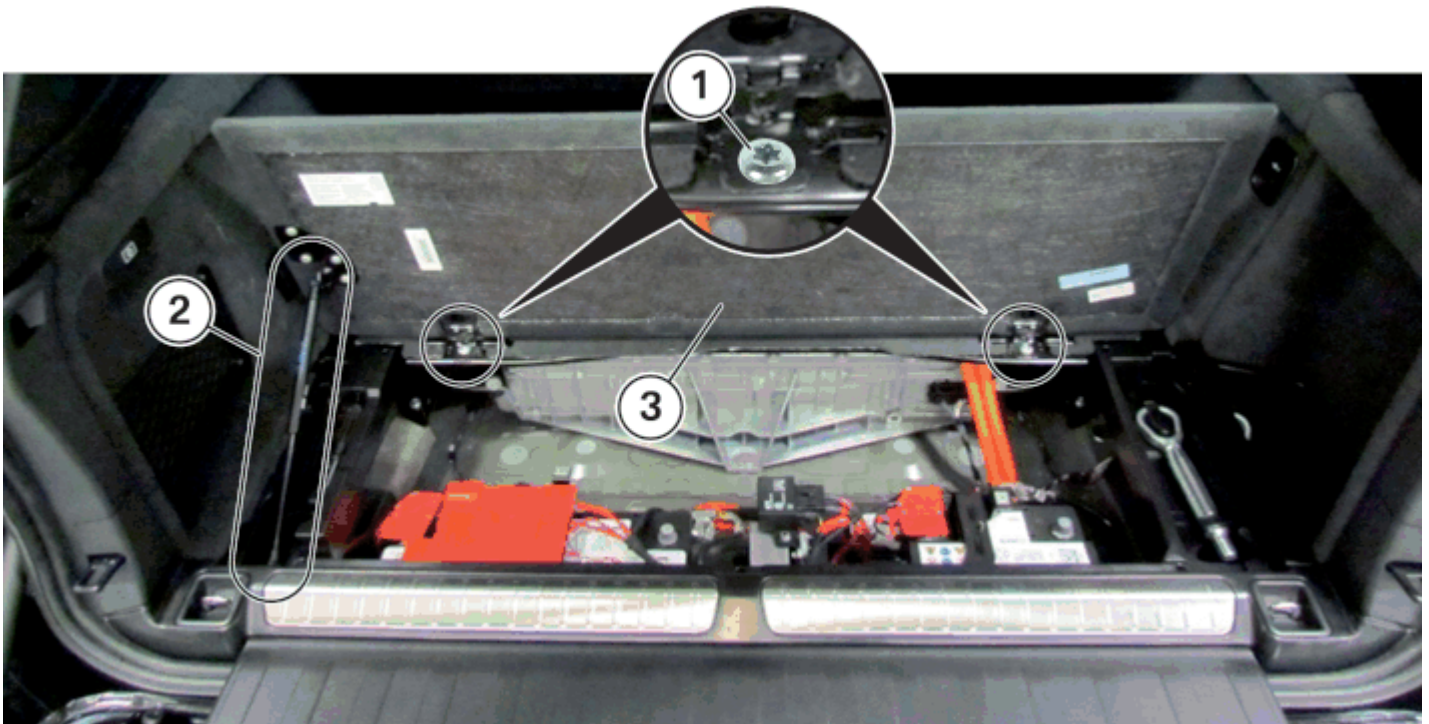

6. Disassemble luggage compartment floor cover:

- Lift the front part and loosen the Torx screw T50 (1). Remove the judder damper (2) and remove the oxygen sensor cover (3).

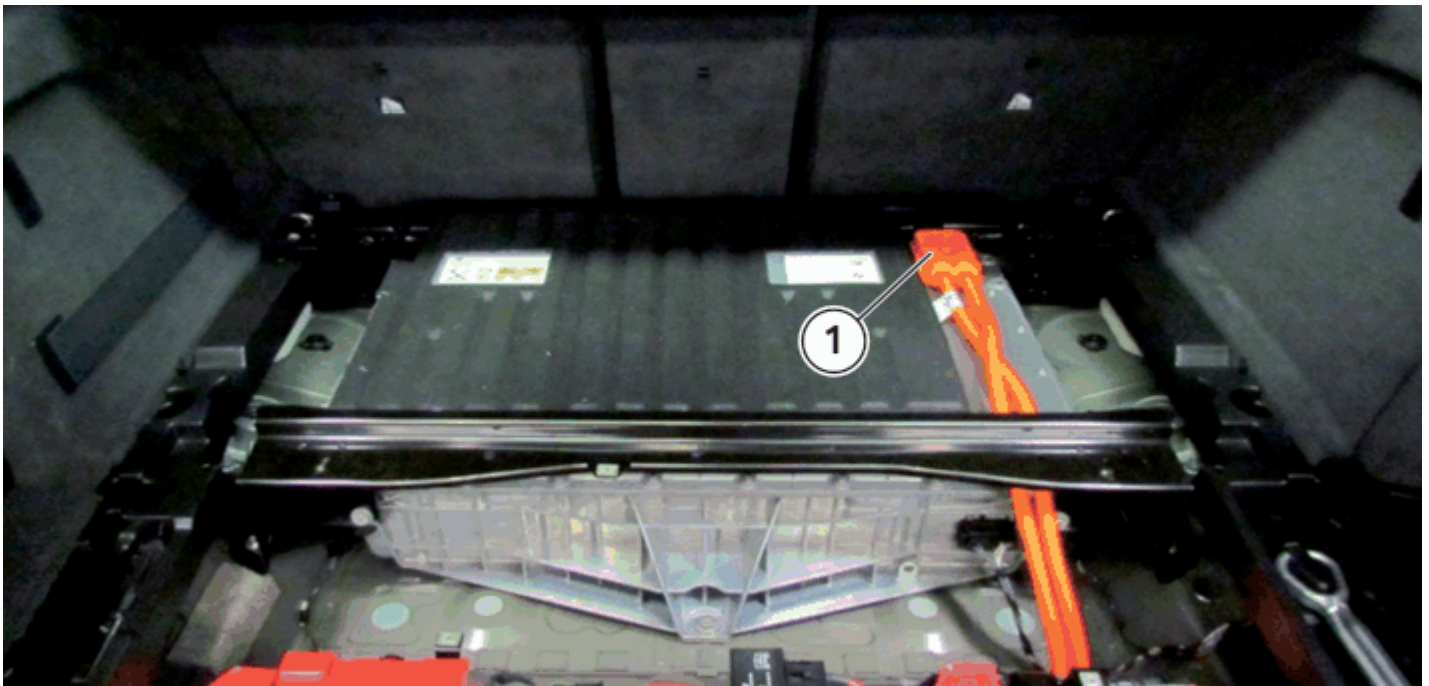

- Lift to remove the rear part, the high-voltage connector (1) is exposed.

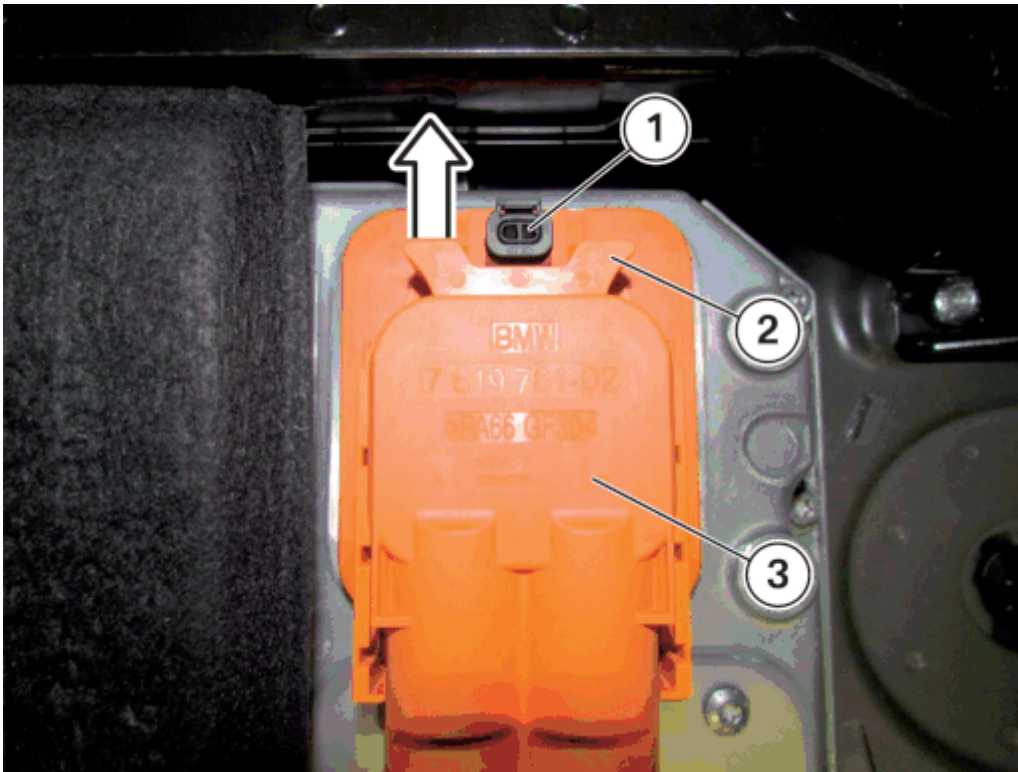

7. Disconnect high-voltage connector.

- Remove "HV interlock" (1)
- Pull out lock (2) in direction of arrow up to limit position
- Pull off high-voltage connector (3)

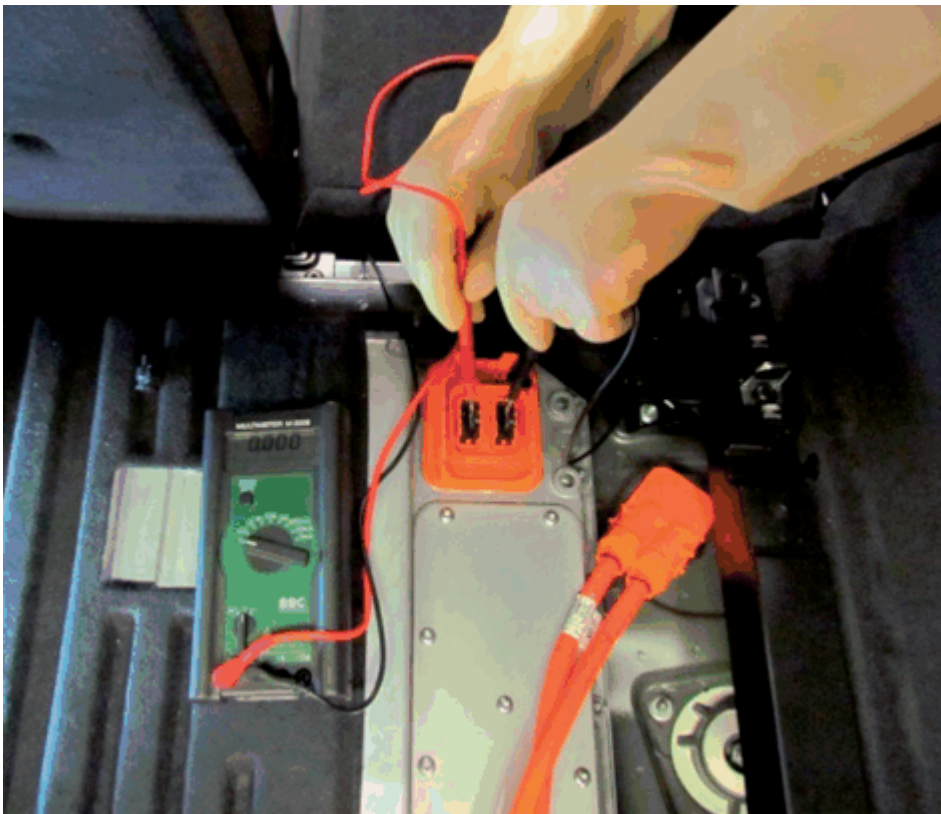

8. Measure the de-energized state at the high-voltage connector

The disconnected high-voltage cable is directly linked to high-voltage battery.

It is essential that the contacts are reached with the gauge tips when measuring.

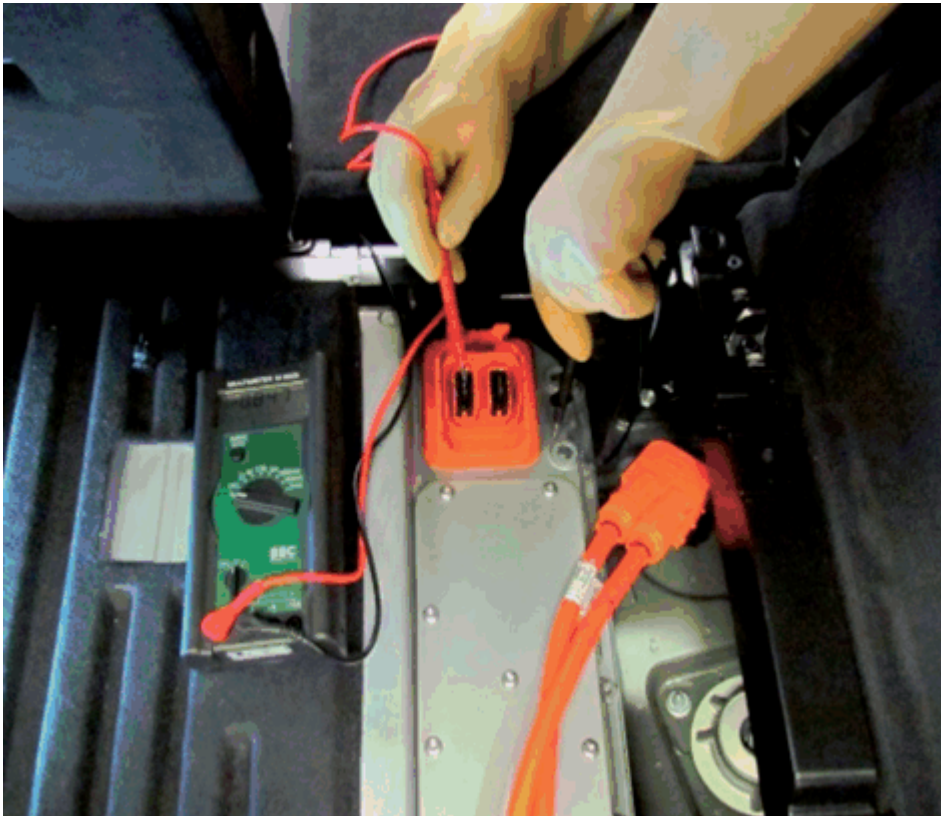

In the next step, the voltage of each of the two contacts to the housing of the electrical machine electronics is measured. The housings of all high-voltage components are connected via GND by means of potential compensation lines. If a high-voltage potential is present at the housing and/or at GND due to damage, it can be measured with this procedure.

If it is not possible to measure the voltage in any of the tests, it can be assumed that there is no risk from the system.

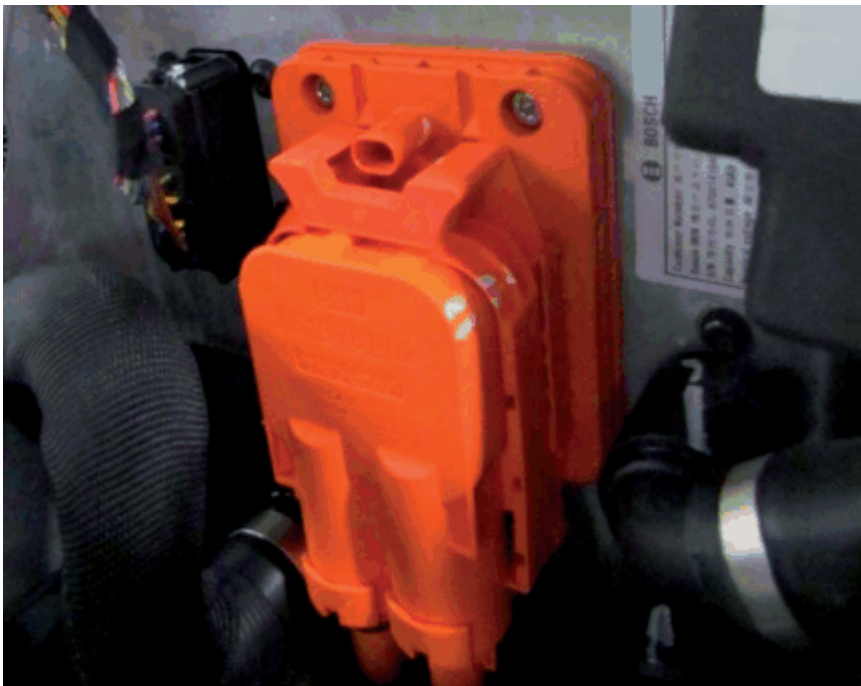

9. Installing the high-voltage connector

In order to rule out further improper treatment, install and lock the high-voltage connector again. The smaller connector (HV interlock) must not be installed again.

3.2 Vehicle fire

In general, all statutory requirements relating to a conventional vehicle on fire are to be observed.

No explosion will occur in the event of a reaction of the lithium ion high-voltage battery triggered by the fire. A quick thermal response will take place. Monitoring the high-voltage battery with a thermographic camera is therefore recommended.

Trapped persons can be rescued using suitable fire fighting equipment.

As with conventional vehicles, hazardous smoke may be produced if the vehicle catches fire (e.g. due to burning plastics).

CAUTION

There is an electrical risk even after a vehicle has been on fire.

Danger of injury!

- Use personal protective equipment identical to that for conventional vehicle fires.
- Do not touch high-voltage components.

3.2.1 Extinguishing

In the event of fire, the high-voltage battery is to be cooled with a lot of water in order to prevent further reactions inside the high-voltage battery. When extinguishing the fire, audible processes can occur inside the high-voltage battery. This takes place in the safety valves of the battery cells. This process is no source of danger. These audible processes can also occur after extinguishing the fire.

CAUTION

BGI/GUV-I 8677 electrical risks at the scene of deployments.

Danger of injury!

- Observe the following safety distance when extinguishing:
- 1 m for spray jet
- 5 m for full jet

3.2.2 Determining the burnt-out vehicle has been de-energised

There may still be electrical hazard potential after the fire. The insulation of the high-voltage cables can be damaged or even removed by the heat.

In this case, the vehicle may only be approached when wearing personal protecting equipment.

As described in chapter 3.1.2, point 8, both cables need to be checked for the de-energised state in this case as well. In the next step, measurements need to be taken between both cables and the housing of the high-voltage battery. Further cables can be checked in the front part of the vehicle, if necessary. If a voltage potential is still present, the high-voltage cables coming out of the high-voltage battery need to be disconnected from the high-voltage battery. Therefore, the copper lines are to be insulated against each other and to be cut through **one by one** in order to prevent a short circuit. Afterwards, a short circuit to ground should be checked.

Note: The high-voltage cables of the high-voltage battery can be identified by their considerably greater cross-section. If the insulation is melted due to the fire, only the copper lines can be identified.

3.3 Vehicles in and under water

Disconnect the high-voltage service disconnect and the 12 V battery (negative terminal) to switch off the high-voltage system after having recovered the vehicle from bodies of water. In case of airbag deployment, the switch-off of the high-voltage system can be assumed. Touching high-voltage components and high-voltage cables is to be avoided.

i TECHNICAL INFORMATION

After recovering the vehicle from water:

- Monitor the vehicle.
- Store the vehicle outdoors and keep at a sufficient distance from combustible materials.
- Provide unobstructed access for the fire brigade.

3.4 Split high-voltage batteries or high-voltage batteries that have been separated from the vehicle

The voltage within the high-voltage battery cannot in principle be switched off. The high-voltage battery is, however, designed to be intrinsically safe on the inside. This includes, for example, an adequate touching protection. All high-voltage cables can be plugged in and are highlighted in orange. In case of a damaged high-voltage battery, a damaged touching protection needs to be assumed.

In this very improbable case, electrical and thermal danger by the high-voltage battery need to be assumed. Adequate personal protective equipment is required.

The elements of the high-voltage battery should be lifted from the ground with insulating material (for example wood). If any elements are held together only by individual lines, disconnecting and/or cutting through the lines may be recommended. Disconnect and/or cut through lines one by one in order to provide dangerous short circuits.

The elements can be lifted onto a truck with insulating facing on the loading platform and then be covered with an insulating cover. Install an adequate high-voltage sign with a corresponding note.

First recovery of the vehicle with damaged high-voltage battery is secured by law.

4 Towing

When towing away a severely damaged vehicle, the following points need to be kept in mind:

- Observe notes on towing away inside the rescue manual, the emergency services data sheet and/or the Owner's Handbook.
- The vehicle may only be towed away by trained personnel.
- The high-voltage system is to be switched off before transporting (de-energised).
- Insulating tensioning straps and lifting gear are to be used.
- Not specifically trained persons are to be kept away.
- If the vehicle does not stand on its own wheels, adequate insulation material is to be used. The vehicle body may not have any metallic contact to the loading platform.

- The elements of the high-voltage battery can be lifted onto a truck with insulating facing on the loading platform and then be covered with an insulating cover.
- The vehicle is to be secured sufficiently in order to avoid further damage to the high-voltage battery due to movement.
- If the vehicle can be repaired, it should be transported to the nearest BMW authorised workshop if possible.

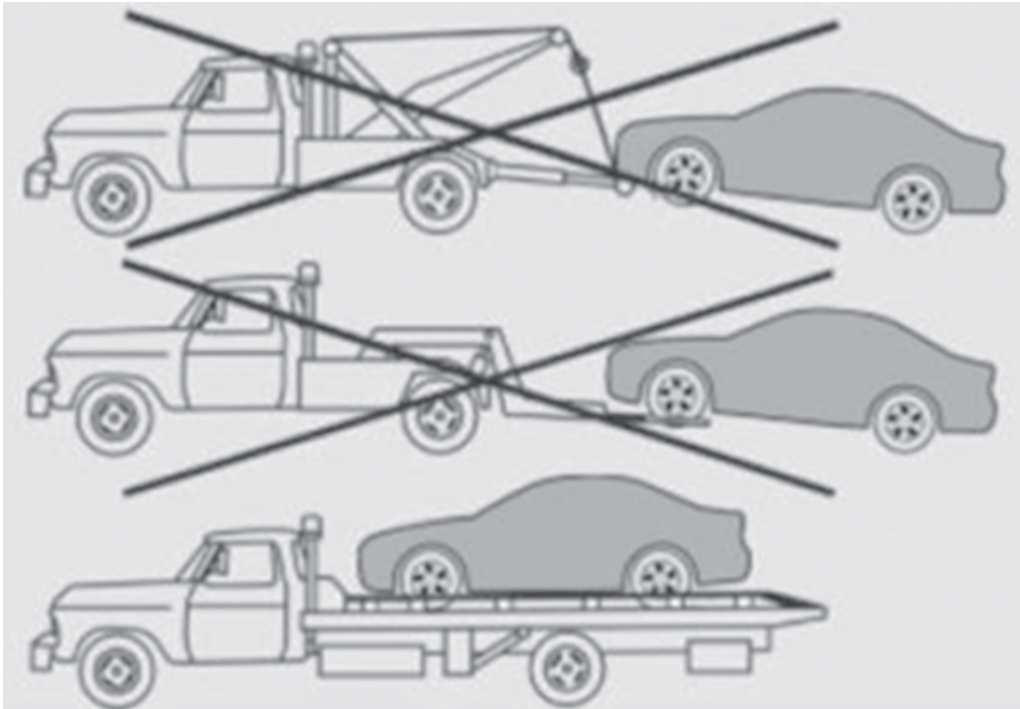

The vehicle must not be pulled or towed. Transportation is possible exclusively on a truck. Any other variants of towing away a vehicle are forbidden. Pulling the vehicle out of the danger area is possible. Securing the vehicle via its wheels is recommended.

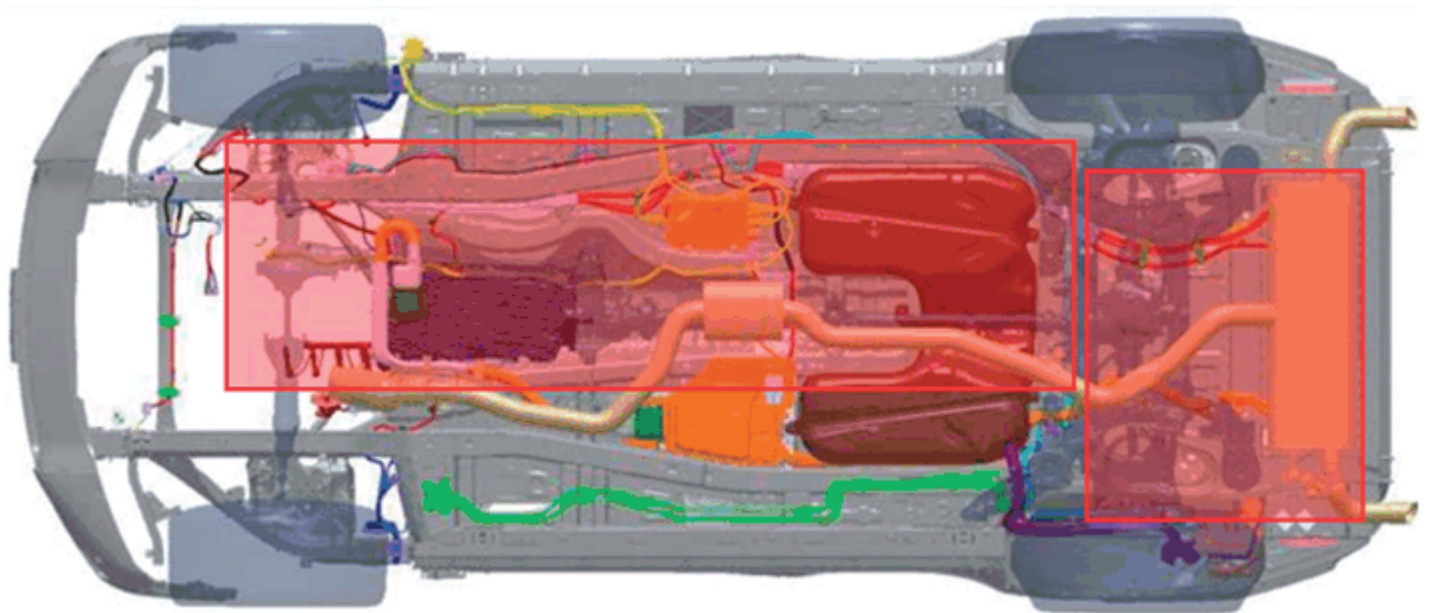

When lifting the vehicle, the areas surrounded by red colour may not be used as a supporting area (exception: after a fire)



Deactivating high-voltage system (de-energised)

The luggage compartment features the high-voltage rescue isolation point (EBO: on the right behind the luggage compartment trim panel) and both 12 V batteries (system battery and auxiliary battery).

The high-voltage system is deactivated by:

- Remove the red connector lock (1) and pull apart the plug connection of the high-voltage rescue isolation point (2) (high-voltage service disconnect)

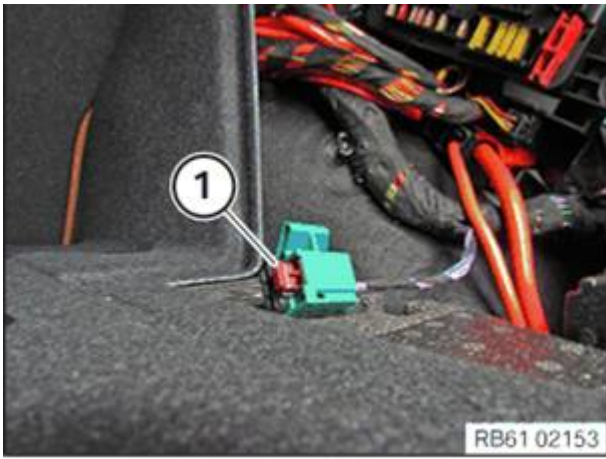

- Disconnect the 12 V batteries at the negative terminal (see emergency services data sheet)

If the high-voltage rescue separation point behind the trim panel cannot be accessed, the high-voltage system is switched off at the large high-voltage connector of the high-voltage battery (installation position below the luggage compartment floor cover).

The high-voltage system can be switched-off by removing the small pole connector (HV interlock).



3.1.2 De-energising the system

A switched off high-voltage system can be identified via the message "High-voltage system deactivated" in the instrument cluster.



Note: Connect the 12 V battery and carry out a terminal change (switch the vehicle off and on again using the start/stop button) to display the information.

If the de-energised state cannot be identified by means of the instrument cluster, the state can be identified by a qualified electrical specialists with personal protective equipment via the following measurements.

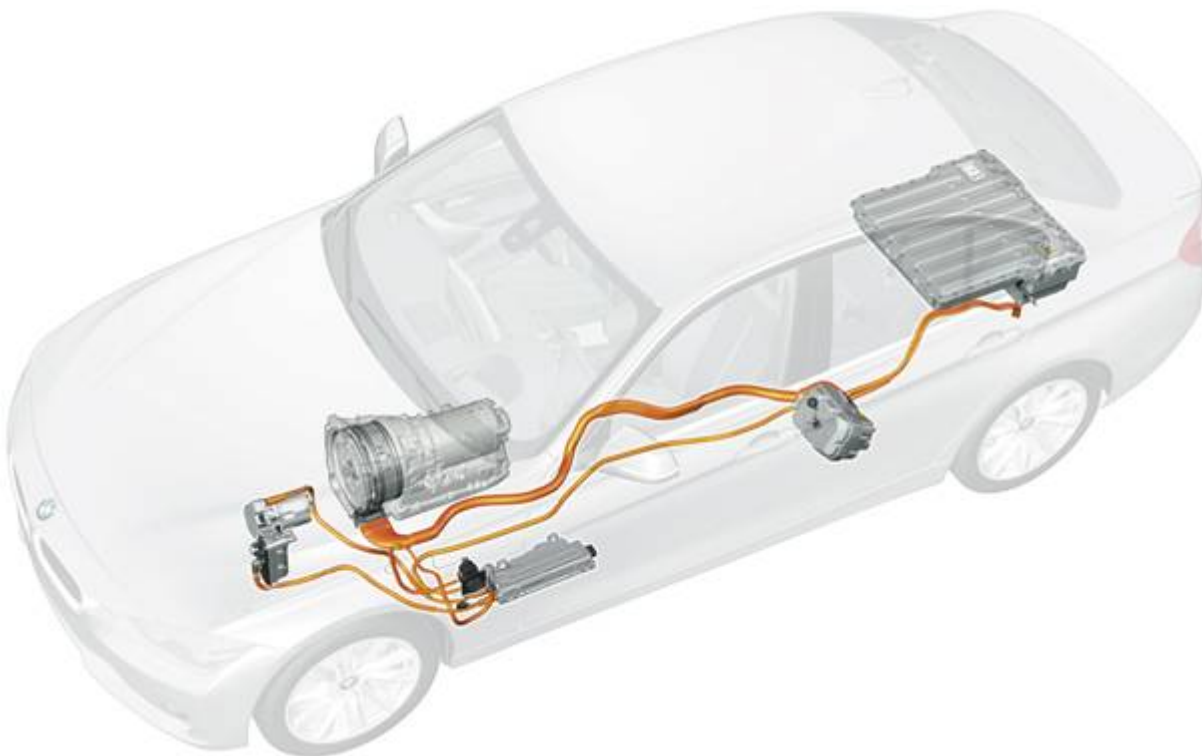

Position of the high-voltage components

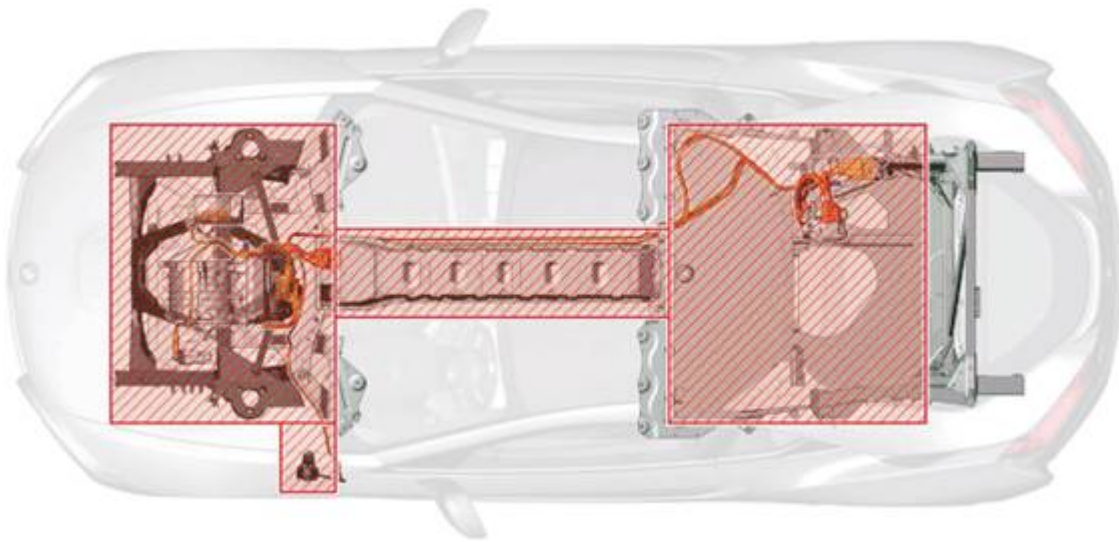

Lifting the vehicle for vehicle recovery:

When lifting the vehicle, the areas surrounded by red colour may not be used as a supporting area (exception: after a fire)

Experts guide 2 series F45 PHEV



Deactivating high-voltage system (de-energised)

The luggage compartment features the high-voltage rescue isolation point (EBO: on the right behind the luggage compartment trim panel) and both 12 V batteries (system battery and auxiliary battery).

The high-voltage system is deactivated by:

- Remove the red connector lock (1) and pull apart the plug connection of the high-voltage rescue isolation point (2) (high-voltage service disconnect)

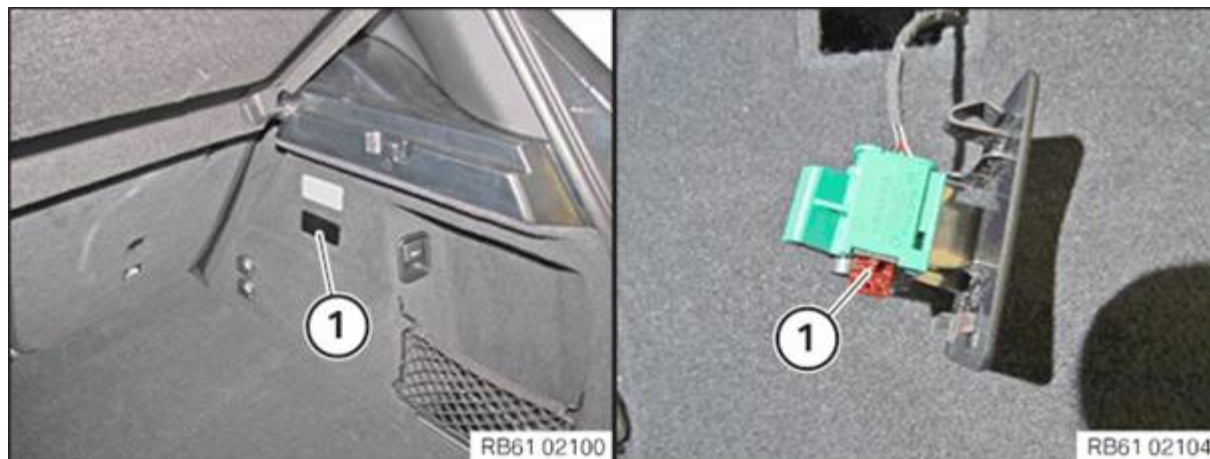

- Disconnect the 12 V batteries at the negative terminal (see emergency services data sheet)

If the high-voltage rescue separation point behind the trim panel cannot be accessed, the high-voltage system is switched off at the large high-voltage connector of the high-voltage battery (installation position below the luggage compartment floor cover).

The high-voltage system can be switched-off by removing the small pole connector (HV interlock).



3.1.2 De-energising the system

A switched off high-voltage system can be identified via the message "High-voltage system deactivated" in the instrument cluster.



Note: Connect the 12 V battery and carry out a terminal change (switch the vehicle off and on again using the start/stop button) to display the information.



Position of the high-voltage components

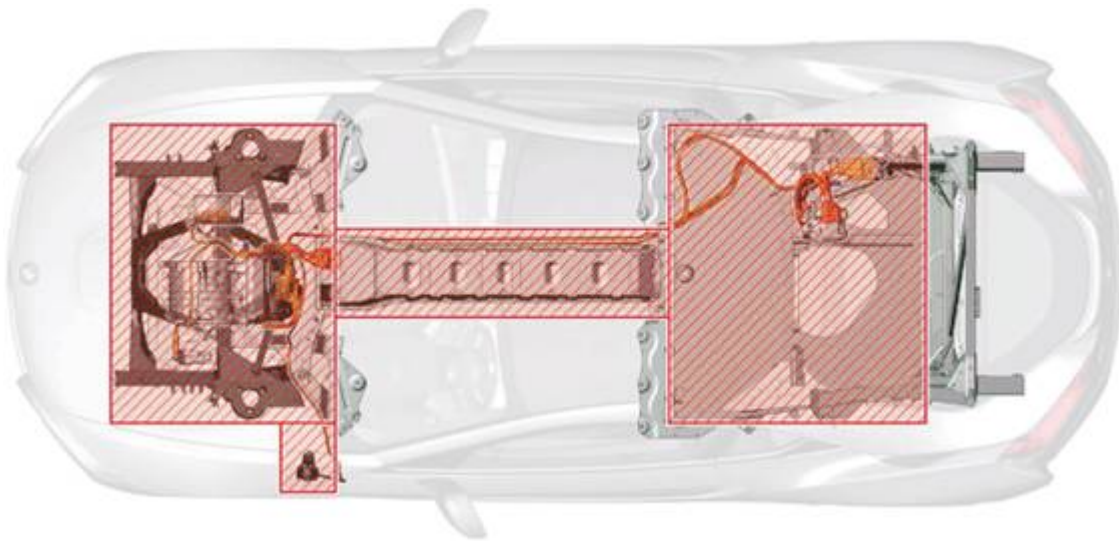

Lifting the vehicle for vehicle recovery:

When lifting the vehicle, the areas surrounded by red colour may not be used as a supporting area (exception: after a fire)

Experts guide 7 Series G11 PHEV



Deactivating high-voltage system (de-energised)

The luggage compartment features the high-voltage rescue isolation point (EBO: on the right behind the luggage compartment trim panel) and both 12 V batteries (system battery and auxiliary battery).

The high-voltage system is deactivated by:

- Remove the red connector lock (1) and pull apart the plug connection of the high-voltage rescue isolation point (2) (high-voltage service disconnect)

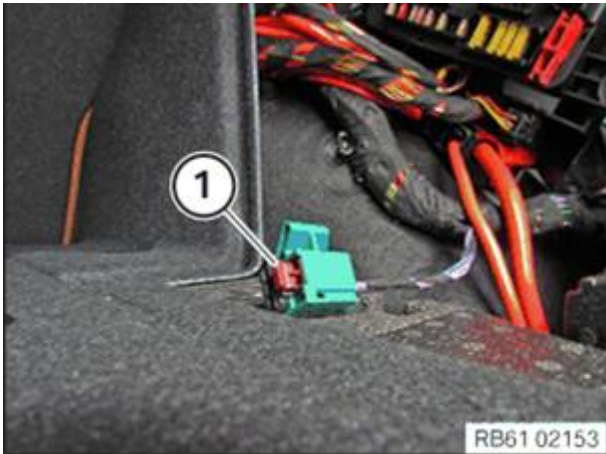

- Disconnect the 12 V batteries at the negative terminal (see emergency services data sheet)

If the high-voltage rescue separation point behind the trim panel cannot be accessed, the high-voltage system is switched off at the large high-voltage connector of the high-voltage battery (installation position below the luggage compartment floor cover).

The high-voltage system can be switched-off by removing the small pole connector (HV interlock).



3.1.2 De-energising the system

A switched off high-voltage system can be identified via the message "High-voltage system deactivated" in the instrument cluster.



Note: The 12 V battery must be connected for display. In addition, the vehicle must be set to Parking/Residing/Driving by pressing the start-stop button 3 times within 0.8 seconds.

If the de-energised state cannot be identified by means of the instrument cluster, the state can be identified by a qualified electrical specialists with personal protective equipment via the following measurements.



- Remove the cover (1) above the high-voltage connector

- Remove the "HV interlock" fuse (2)

- Pull the lock out to the limit position
- Disconnect the high-voltage connector (3)



The disconnected high-voltage cable is directly linked to high-voltage battery.

It is essential that the contacts are reached with the gauge tips when measuring.



In the next step, measurements can be taken from each of the contacts to the housing of the high-voltage battery. The housings of all high-voltage components are connected via GND by means of equipotential compensation lines. If a high-voltage potential is present at the housing and/or at GND due to damage, it can be measured with this procedure.

If it is not possible to measure the voltage in any of the tests, it can be assumed that there is no risk from the system.

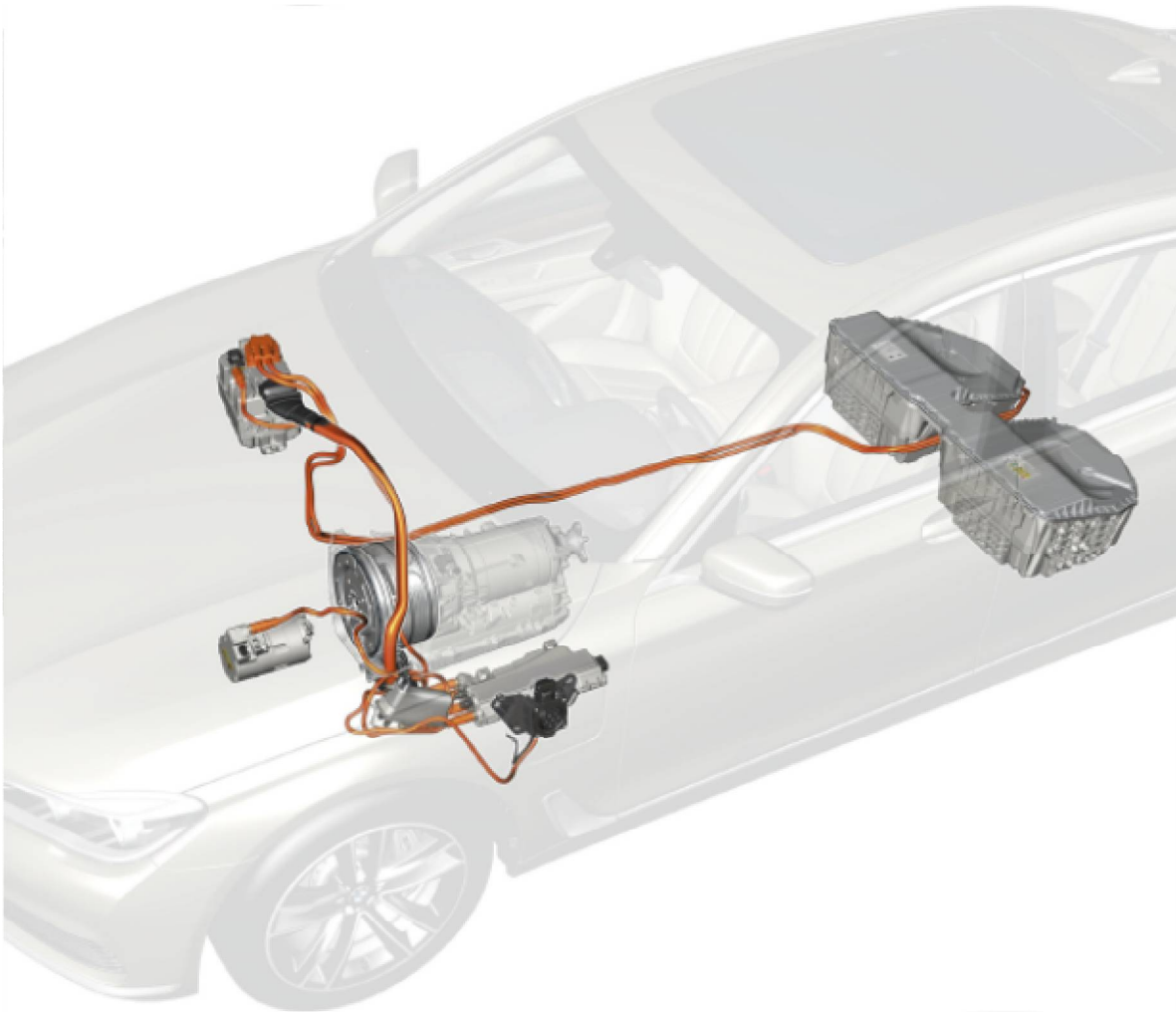

Position of the high-voltage components

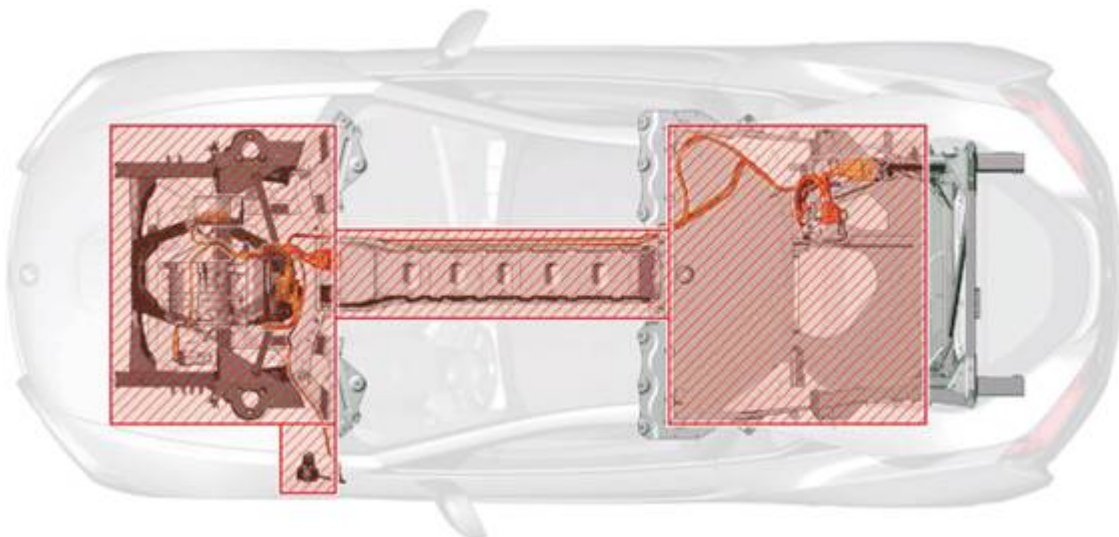

Lifting the vehicle for vehicle recovery:

When lifting the vehicle, the areas surrounded by red colour may not be used as a supporting area (exception: after a fire)

Experts guide 5 series G30 PHEV



Deactivating high-voltage system (de-energised)

The luggage compartment features the high-voltage rescue isolation point (EBO: on the right behind the luggage compartment trim panel) and both 12 V batteries (system battery and auxiliary battery).

The high-voltage system is deactivated by:

- Remove the red connector lock (1) and pull apart the plug connection of the high-voltage rescue isolation point (2) (high-voltage service disconnect)

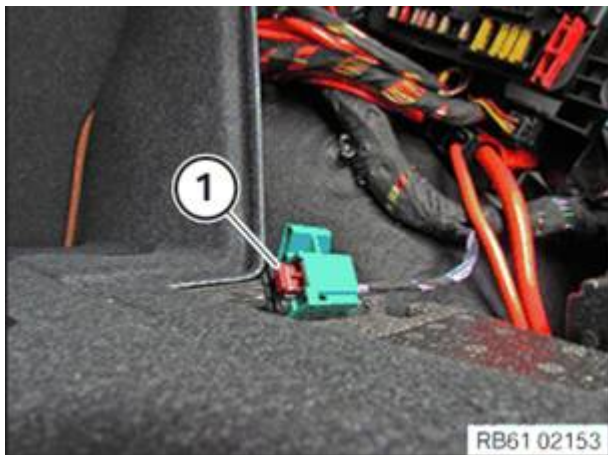

- Disconnect the 12 V batteries at the negative terminal (see emergency services data sheet)

If the high-voltage rescue separation point behind the trim panel cannot be accessed, the high-voltage system is switched off at the large high-voltage connector of the high-voltage battery (installation position below the luggage compartment floor cover).

The high-voltage system can be switched-off by removing the small pole connector (HV interlock).



3.1.2 De-energising the system

A switched off high-voltage system can be identified via the message "High-voltage system deactivated" in the instrument cluster.



Note: The 12 V battery must be connected for display. In addition, the vehicle must be set to Parking/Residing/Driving by pressing the start-stop button 3 times within 0.8 seconds.

If the de-energised state cannot be identified by means of the instrument cluster, the state can be identified by a qualified electrical specialists with personal protective equipment via the following measurements.



- Remove the cover (1) above the high-voltage connector
- Remove the "HV interlock" fuse (2)
- Pull the lock out to the limit position
- Disconnect the high-voltage connector (3)



The disconnected high-voltage cable is directly linked to high-voltage battery.

It is essential that the contacts are reached with the gauge tips when measuring.



In the next step, measurements can be taken from each of the contacts to the housing of the high-voltage battery. The housings of all high-voltage components are connected via GND by means of equipotential compensation lines. If a high-voltage potential is present at the housing and/or at GND due to damage, it can be measured with this procedure.

If it is not possible to measure the voltage in any of the tests, it can be assumed that there is no risk from the system.

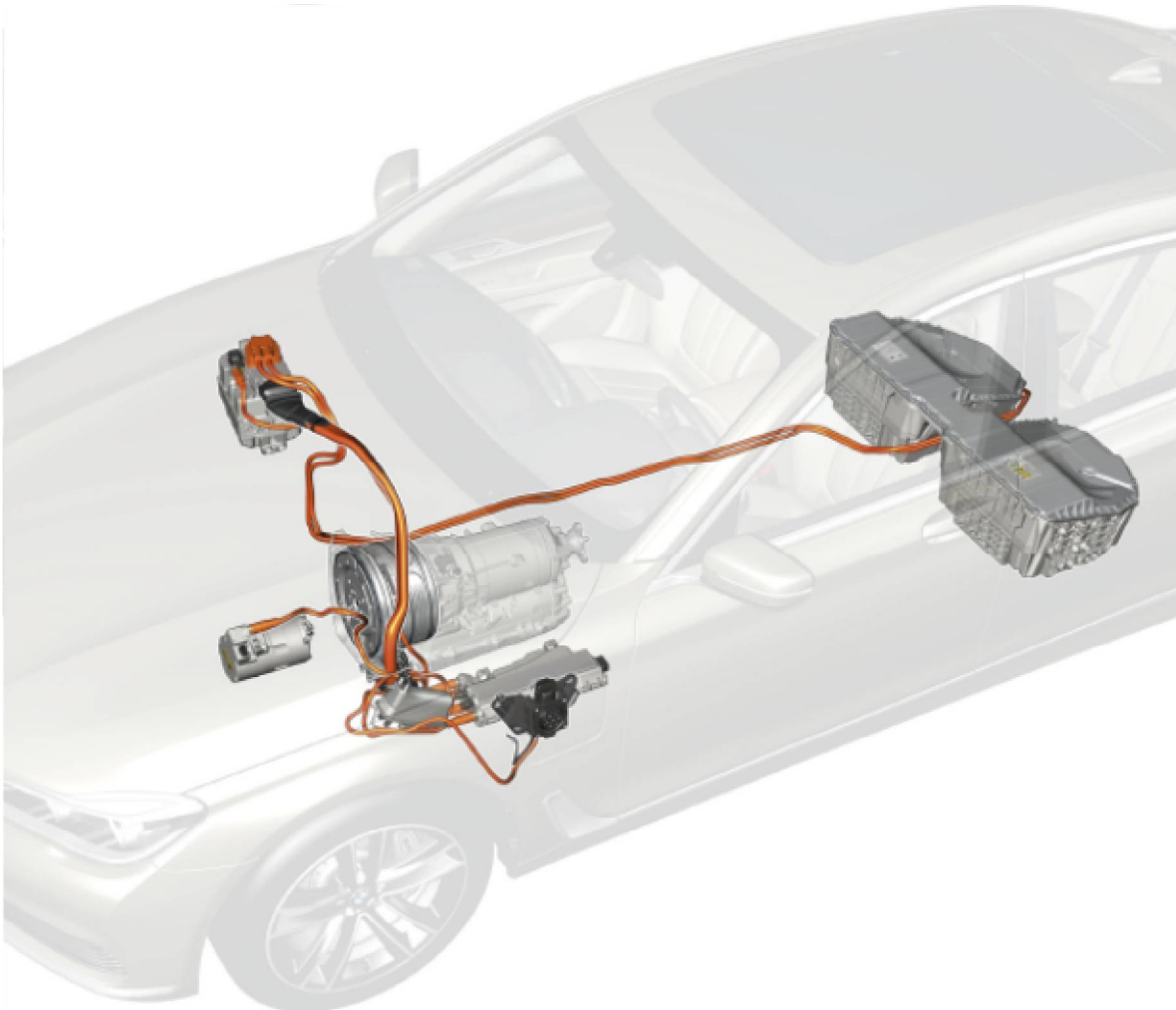

Position of the high-voltage components

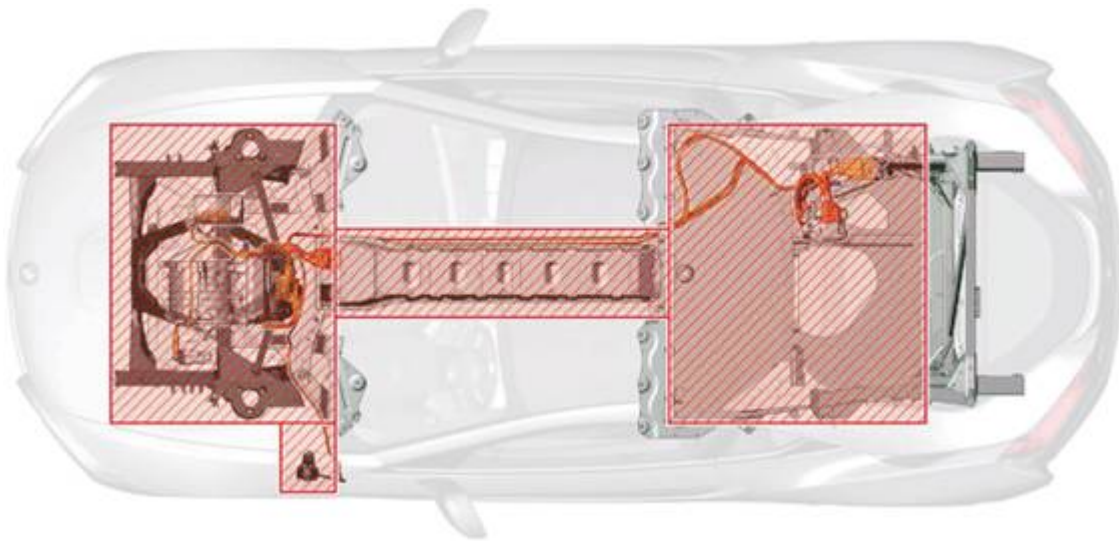

Lifting the vehicle for vehicle recovery:

When lifting the vehicle, the areas surrounded by red colour may not be used as a supporting area (exception: after a fire)

Expert guide MINI F60 PHEV



Deactivating high-voltage system (de-energised)

The luggage compartment features the high-voltage rescue isolation point (EBO: on the right behind the luggage compartment trim panel) and both 12 V batteries (system battery and auxiliary battery).

The high-voltage system is deactivated by:

- Remove the red connector switch fuse (1) and pull apart the plug connection of the high-voltage rescue disconnect (service disconnect)

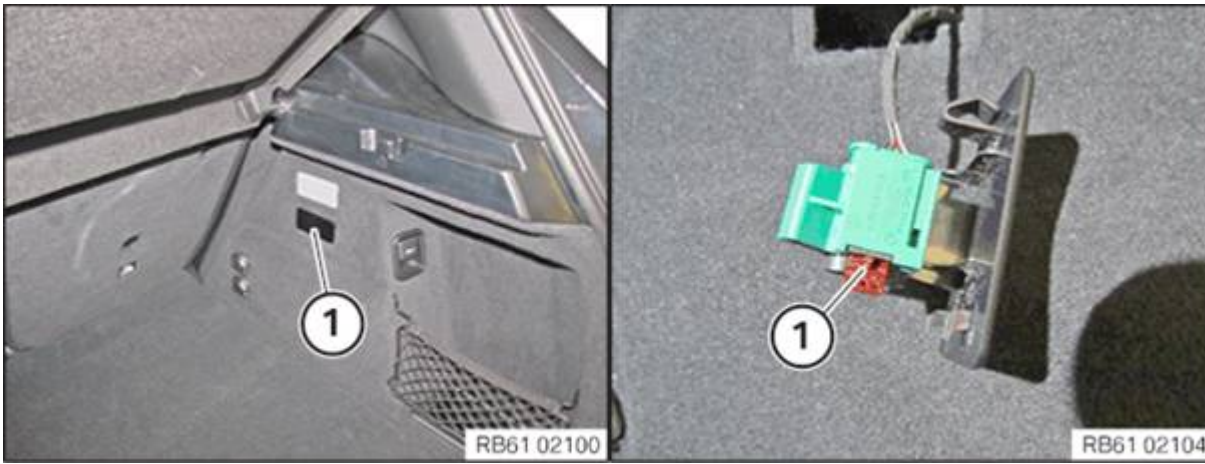

- Disconnect the 12 V batteries at the negative terminal (see emergency services data sheet)

If the high-voltage rescue separation point behind the trim panel cannot be accessed, the high-voltage system is switched off at the large high-voltage connector of the high-voltage battery (installation position below the luggage compartment floor cover).

The high-voltage system can be switched-off by removing the small pole connector (HV interlock).



3.1.2 De-energising the system

A switched off high-voltage system can be identified via the message "High-voltage system deactivated" in the instrument cluster.



Note: Connect the 12 V battery and carry out a terminal change (switch the vehicle off and on again using the start/stop button) to display the information.



Position of the high-voltage components

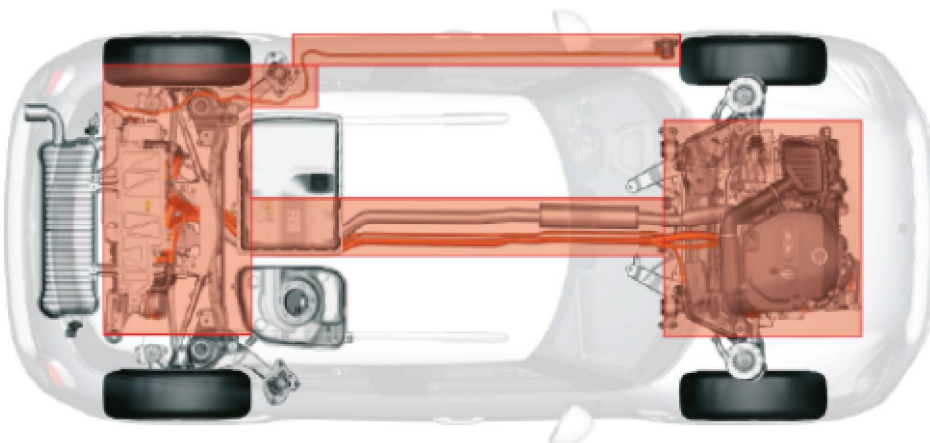

Lifting the vehicle for vehicle recovery:

When lifting the vehicle, the areas surrounded by red colour may not be used as a supporting area (exception: after a fire)

